

Multi-CD/MD/DAB control DSP
CD player with RDS tuner

Reproductor de CD con DSP, control de
multi-CD/MD/DAB y sintonizador RDS

ENGLISH

DEX-P99R

Operation Manual Manual de Operación



 **PIONEER**[®]
The Art of Entertainment

Contents

Key Finder	3	Using the Built-in CD Player	26
Before Using This Product	5	Basic Operation of the Built-in CD Player	26
About This Product	5	Switching the Display	
About This Manual	5	(only for CD TEXT Discs)	27
Resetting the Microprocessor	6	Entering the Function Menu	28
Precaution	6	Entering the Detailed Setting Menu	29
In Case of Trouble	6	Repeat Play	29
Remote Controller and Care	7	Random Play	30
Using the Remote Controller	7	Scan Play	30
Using the Steering Remote Controller	8	Pause	31
Detaching and Replacing		CD Sound Quality Adjustment	31
the Front Panel	10	Disc Title Input	31
Theft Protection	10	CD Player and Care	32
Basic Operation	11	Disc Selection and Care	32
Switching Power ON/OFF	11	Precaution	32
Tuner Operation	12	Built-in CD Player Troubleshooting	33
Basic Operation of Tuner	12	Error Message	33
Entering the Function Menu	13	Using Multi-CD Players	34
Local Seek Tuning	14	Basic Operation of Multi-CD Players	34
Preset Tuning	15	Playing Discs on a 50-Disc Type	
Using the RDS Functions	17	Multi-CD Player	35
What is RDS?	17	Switching the Multi-CD Player	35
Switching the Frequency Display	17	Disc Number Search	36
AF Function	18	Entering the Function Menu	37
PI Seek Function	19	Entering the Detailed Setting Menu	38
Regional Function	19	Pause	38
TA Function	20	CD Sound Quality Adjustment	39
PTY Function	22	Multi-CD Player Repeat Modes	40
		Multi-CD Player Random Play	41
		Multi-CD Player Scan Play	41
		ITS (Instant Track Selection)	42
		Disc Title Input	45
		Music Group Play (for 50-Disc type only)	49
		Displaying Disc Title or Music Group	
		(for 50-Disc type only)	51
		Frequency Play (for 50-Disc type only)	51
		Ejecting a Single Disc	
		(for 50-Disc type only)	52

Using the Digital Signal Processor (DSP) 53

- Common Functions 53
- Special PRO (Professional) Mode Function 54
- Special STD (Standard) Mode Function 54
- Switching the Operation Mode 55
- Entering the DSP Function Menu 56
- Entering the DSP Detailed Setting Menu 57
- Position Selector Function 58
- Time Alignment Function (PRO mode) 59
- Network Function 61
- Auto-equalizing Function 68
- Error Cords of Auto-equalizing Function 72
- Auto-equalizer Function 72
- Graphic Equalizer Function 73
- Sound Field Control Function (STD mode) 77
- Balance Adjustment Function 78
- Loudness Function 79
- Automatic Sound Levelizer (ASL) Function 79
- Source Level Adjustment (SLA) Function 80

Initial Setting 81

- Entering the Initial Setting Menu 81
- Changing the FM Tuning Step 82
- Setting the DAB Priority Function 82
- Switching the Auto PI Seek Function 83
- Setting the Warning Tone 83
- Switching the AUX Mode 83
- Setting the Dimmer 84
- Selecting the Illumination Color 84
- Switching the DSP Output Level Setting 85
- Switching the Entertainment Display 85

RFP Alert Function 86

- Activating the RFP Alert Feature 86
- Setting Entry Delay Time 87
- Switching Internal Speaker ON/OFF 87
- Setting the Selectable Output (Pulse/Constant) 89
- Selecting Door Switching Systems 89
- Ignition Key Disarm 91
- Central Door Lock Systems 92
- Operation of "RFP Alert" 93
- Arming Alert 93
- Disarming Alert 94
- Entry Detection 94

Other Functions 95

- Using the PGM Button 95
- Adjusting the Angle and Contrast 97
- Selecting the Status Display 98
- Volume Attenuator 98
- Using the AUX Mode 99
- Cellular Telephone Muting 99

Using Multi-MD Players 100

- Basic Operation of Multi-MD Players 100
- Disc Number Search 101
- Title Display Function 102
- Entering the Function Menu 103
- Repeat Play 103
- Selecting Discs by Disc Title 104
- Random Play 104
- Scan Play 105
- Combining Random Play, Scan Play and Repeat Play 106
- Multi-MD Player's Error Message 106

Specifications 107

Key Finder

Head Unit

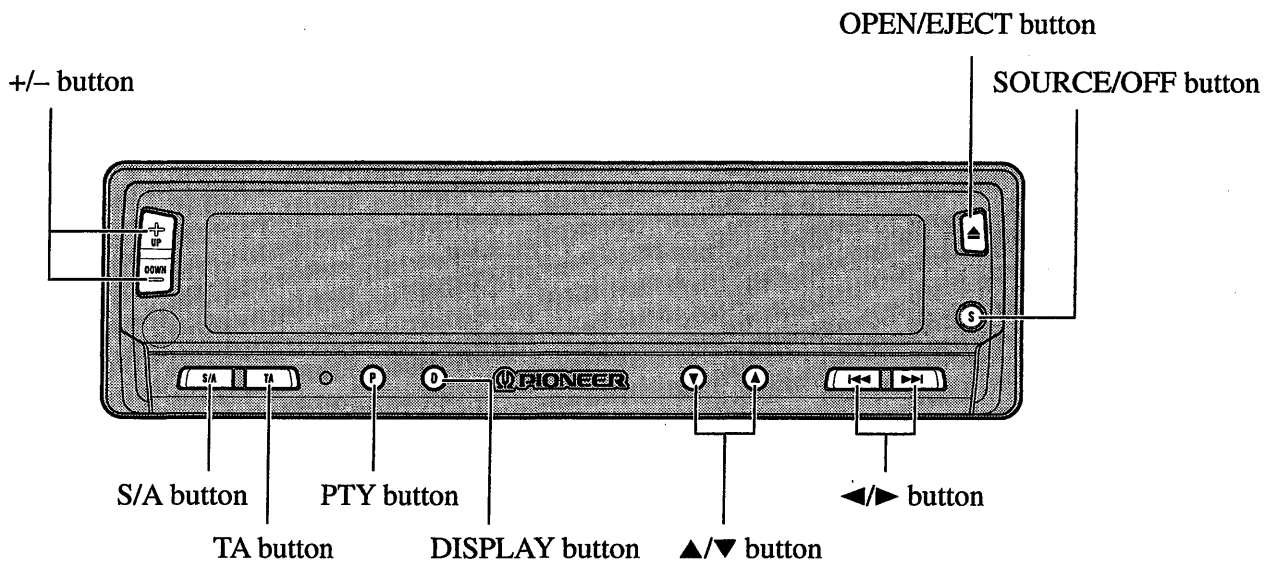

Remote Controller

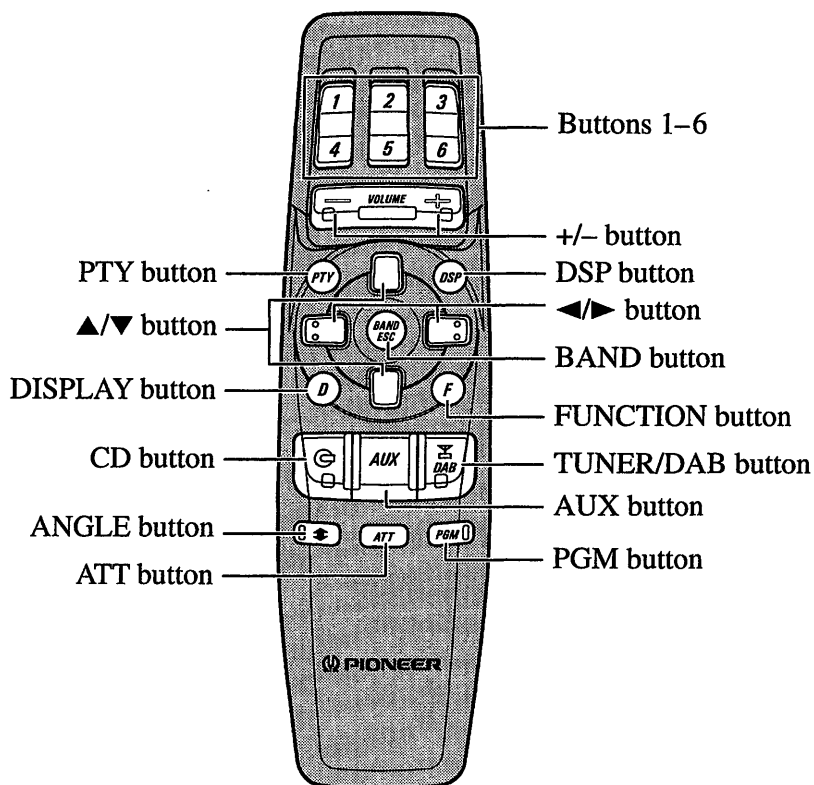

Steering Remote Controller

Buttons on the remote controller or head unit with the same name have the same function.

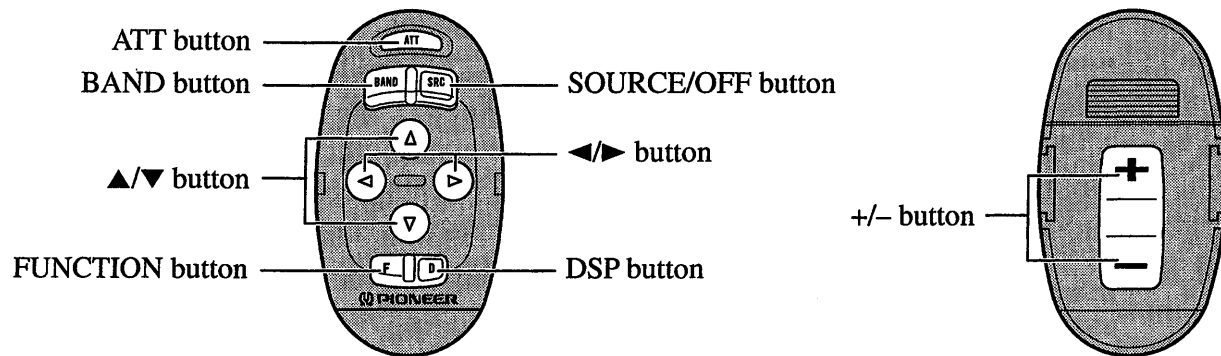

Before Using This Product

About This Product

- This product complies with the EMC Directives (89/336/EEC, 92/31/EEC) and CE Marking Directive (93/68/EEC).

The tuner frequencies on this product are allocated for use in Western Europe, Asia, the Middle East, Africa and Oceania. Use in other areas may result in improper reception. The RDS function operates only in areas with FM stations broadcasting RDS signals.

This product's display features Key Guidance Indicators. These light to indicate which of the ▲/▼/◀/▶, FUNCTION and DSP buttons you can use. When you're in the Function Menu or DSP Menu, they also make it easy to see which ▲/▼/◀/▶ buttons you can use to switch functions ON/OFF, switch repeat selections, and perform other operations.

Indicator and corresponding buttons are shown below.

Indicator	Button
↑	▲
↓	▼
←	◀
→	▶

Key Guidance Indicators
(e.g. ON/OFF indicates.)

⊕ ON
⊕ OFF

About This Manual

This product features a number of sophisticated functions ensuring superior reception and operation. All are designed for the easiest possible use, but many are not self-explanatory. This operation manual is intended to help you benefit fully from their potential and to maximize your listening enjoyment.

We recommend that you familiarize yourself with the functions and their operation by reading through the manual before you begin using this product. It is especially important that you read and observe the "Precaution" on the next page and in other sections.

In this Operation Manual, the Basic Operation for each sound source is outlined at the beginning of its explanation, covering simple operation for that source, such as merely playing music.

Resetting the Microprocessor

The microprocessor must be reset under the following conditions:

When using this product for the first time after installation.

When the machine fails to operate properly.

When strange (incorrect) messages appear on the display.

- **To reset the microprocessor, press the RESET button on the head unit with a pen tip or other pointed instrument.**

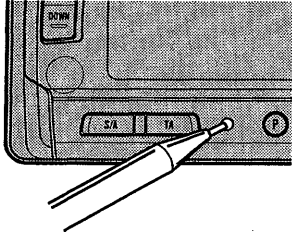

Precaution

- A "CLASS 1 LASER PRODUCT" label is affixed to the bottom of the player.



- The Pioneer CarStereo-Pass is for use only in Germany.
- Keep this manual handy as a reference for operating procedures and precautions.
- Always keep the volume low enough for outside sounds to be audible.
- Protect the product from moisture.
- If the battery is disconnected, the preset memory will be erased and must be reprogrammed.

In Case of Trouble

Should this product fail to operate properly, contact your dealer or nearest authorized PIONEER Service Station.

Remote Controller and Care

Using the Remote Controller

This product is equipped with a remote controller for convenient operation.

- Point the controller in the direction of the front panel to operate.
- When the controller is not in use, attach it firmly to the provided Mounting base.

Precaution:

- Do not store the remote controller in high temperatures or direct sunlight.
- The controller may not function properly in direct sunlight.
- Do not let the remote controller fall onto the floor, where it may become jammed under the brake or accelerator pedal.

Batteries

- Remove the cover on the back of the remote controller and insert the batteries with the (+) and (-) poles pointing in the proper direction.

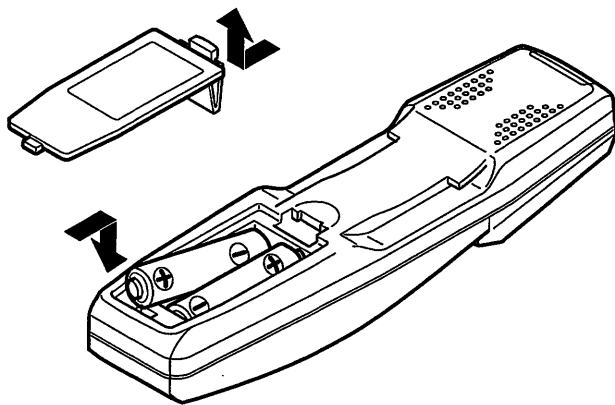

Precaution:

- Use only AAA or IEC R03 1.5 V batteries.
- Remove the batteries if the remote controller is not used for a month or longer.
- Do not attempt to recharge the supplied batteries.
- Do not mix new and used batteries.
- In the event of battery leakage, wipe the remote controller completely clean and install new batteries.

Using the Steering Remote Controller

Precaution:

- Do not operate this unit while manipulating the steering wheel as it might result in a traffic accident.
- If you have to operate this unit unavoidably when driving, look ahead carefully to avoid the risk of being involved in a traffic accident.
- If any of the following troubles occur, immediately stop using this unit and consult with the dealer from whom you purchased it:
 - the unit is smoking.
 - the unit is emitting abnormal odor.
 - a foreign object has entered the unit.
 - liquid has been spilled on or into the unit.If you continue to use this unit without finding a remedy, the unit may be damaged badly, resulting in a serious accident or fire.
- Do not leave this unit free (unattached) inside the car. When the car stops or turns a curve, the unit might drop on the floor. If the unit rolls under the brake pedal, it might prevent the driver from braking well, causing serious trouble. Be sure to fix this unit to the steering wheel.
- Do not disassemble or modify this unit. To do so may cause a fault.

Battery

■ Install the Lithium Battery

- **Remove the cover on the back of the steering remote controller and insert the battery with the (+) and (-) poles pointing in the proper direction.**

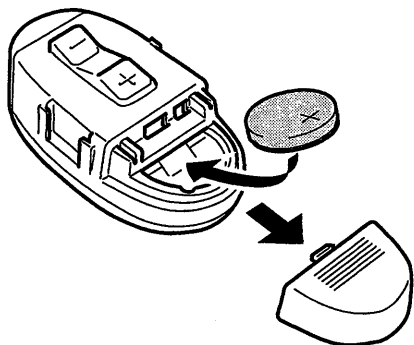

Remote Controller and Care

■ Replacing the Lithium Battery

- Remove the lithium battery.

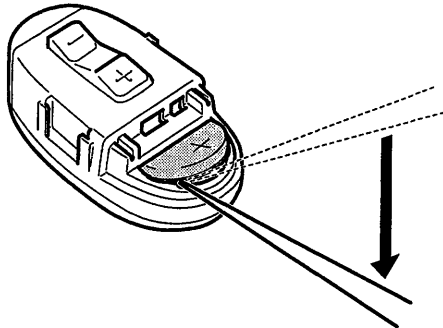

Precaution:

- Replace the battery with a CR2032 lithium battery.
- Replace the battery in the unit using a non metallic tapered instrument.



WARNING

- Keep the lithium battery out of reach of children. Should the battery be swallowed, immediately consult a doctor.



CAUTION

- Do not recharge, disassemble, heat or dispose of battery in a fire.
- Use a CR2032 (3 V) lithium battery only. Never use other types of battery with this unit.
- Do not handle the battery with metallic tools.
- Do not store the lithium battery with metallic materials.
- Dispose of the used lithium battery, in compliance with applicable laws and regulations.
- Always check carefully that you are loading the battery with its (+) and (-) poles facing in the proper directions.

Detaching and Replacing the Front Panel

Theft Protection

The front panel of the main body is detachable to discourage theft.

WARNING

- Do not use with the front panel left open. If you do leave it open, it may result in injury in the event of an accident.

Detaching the Front Panel

- Detach the front panel and store in the protective case.

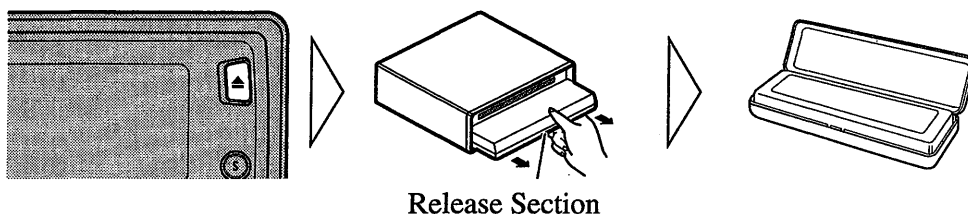

The inner cover closes automatically.
Take care not to grip the front panel tightly or drop it.

Precaution:

- When removing the front panel, be sure to press the release section on the rear of the front panel while pulling.
- A few seconds after turning the ignition switch to ON/OFF, the front panel automatically moves. When this happens, your fingers may become jammed in the panel, so keep your hands away from it.

Replacing the Front Panel

- Replace the front panel by clipping it into place.

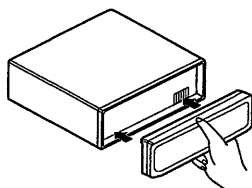

Precaution:

- Never use force or grip the display tightly when removing or replacing the front panel.
- Avoid subjecting the front panel to excessive shocks.
- Keep the front panel out of direct sunlight and high temperatures.

Warning Tone

If the front panel is not detached within 5 seconds after the ignition is turned off, a warning tone will sound.

Note:

- You can cancel the warning tone function. (See page 83.)

Basic Operation

Switching Power ON/OFF

- Select the desired source (such as the tuner).

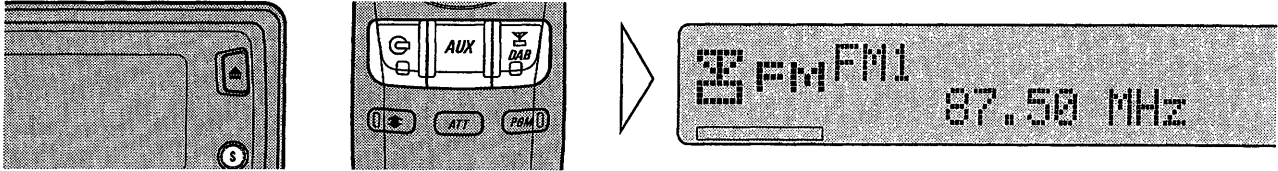

■ Head Unit and Steering Remote Controller

Each press of the SOURCE/OFF button selects the desired source in the following order:

Built-in CD player → Tuner → DAB (Digital Audio Broadcasting) → Multi-MD player → Multi-CD player → AUX

To switch the sources OFF, hold down the SOURCE/OFF button for 1 second or more.

■ Remote Controller

Each press of the button selects the desired source in the following order:

TUNER/DAB button : Tuner → DAB (Digital Audio Broadcasting) → OFF

AUX button : Multi-MD player → AUX → OFF

CD button : Built-in CD player → Multi-CD player → OFF

Note:

- In the following cases, the sound source will not change:
 - * When a product is not connected to this unit.
 - * When no disc is loaded in this product.
 - * When no magazine is loaded in the Multi-CD player.
 - * When the AUX (external input) is set to OFF. (See page 83.)

Tuner Operation

This product's AF function can be switched ON and OFF. AF should be switched OFF for normal tuning operations. (Refer to page 18.)

Basic Operation of Tuner

1. Select Tuner.

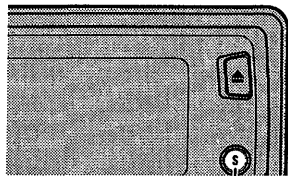

Each press changes the Source ...

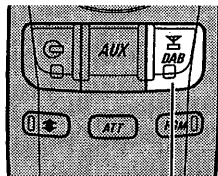

Each press changes the Source ...

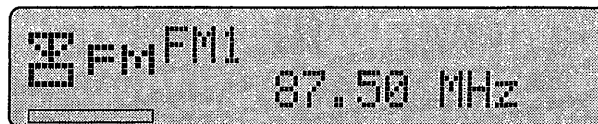

The program service name or frequency appears on the display.

2. Select the desired band.

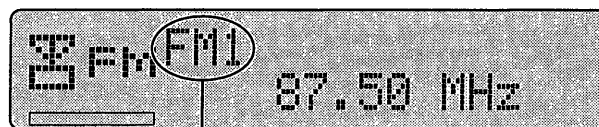
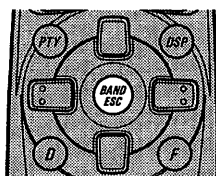

FM1 → FM2 → FM3 → MW/LW

3. Tune the receiver to a higher or lower frequency.

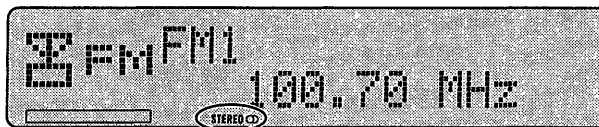
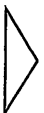
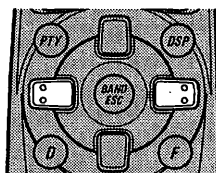
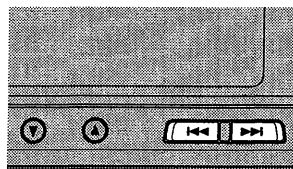

"STEREO 

This product's tuner lets you select the tuning by changing the length of the time you press the button.

Manual Tuning (step by step)	0.3 seconds or less
Seek Tuning (automatically)	0.3–2 seconds
Manual Tuning (continuously)	2 seconds or more

Note:

- "STEREO 
- To select a weak broadcasting station that cannot be tuned in with the Seek Tuning function, tune in with Manual Tuning.

Tuner Operation

4. Raise or lower the volume.

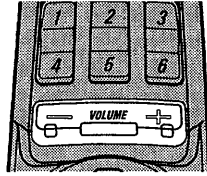
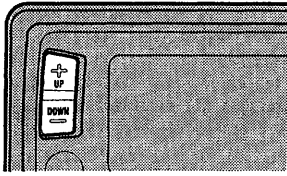

5. Turn the source OFF.

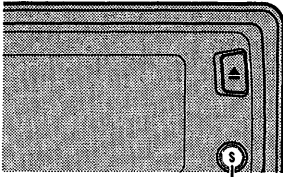

Hold for 1 second

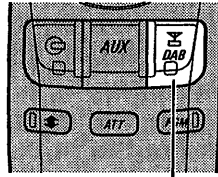

Each press changes the Source ...

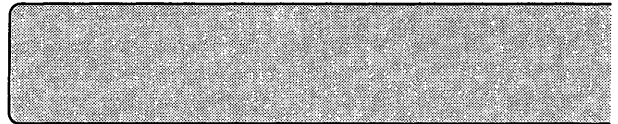
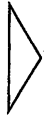

Entering the Function Menu

In this menu you can select tuner functions.

- Select the desired mode in the Function Menu.

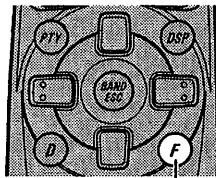

Each press changes the Mode ...

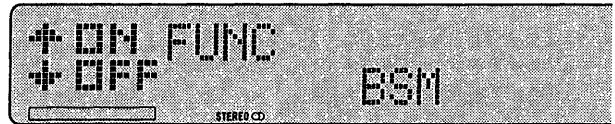
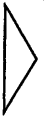

Each press of the FUNCTION button selects the mode in the following order:

BSM → Regional* → Local → TA* → AF*

* Regional, TA and AF are RDS functions for FM bands. You cannot switch to these modes when selecting MW or LW band. Refer to "Using the RDS Functions" for details and instructions on how to use these functions.

To cancel the Function Menu, press the BAND button.

Note:

- After entering the Function Menu, if you do not perform an operation within about 30 seconds, the Function Menu is automatically canceled.

Local Seek Tuning

This mode selects only stations with especially strong signals.

1. Select the Local mode (Local) in the Function Menu.
2. Switch the Local mode ON or OFF.

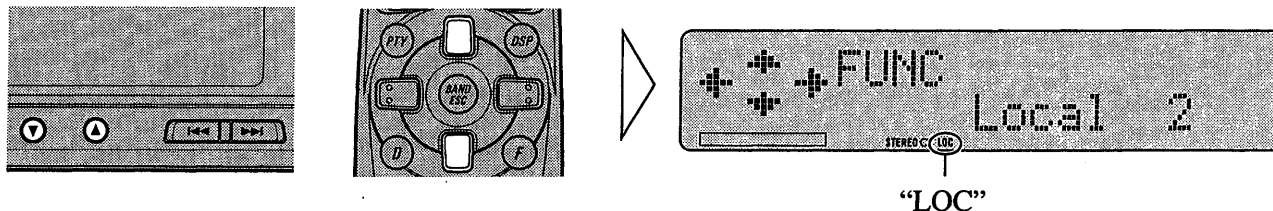

3. Select the desired Local Seek sensitivity.

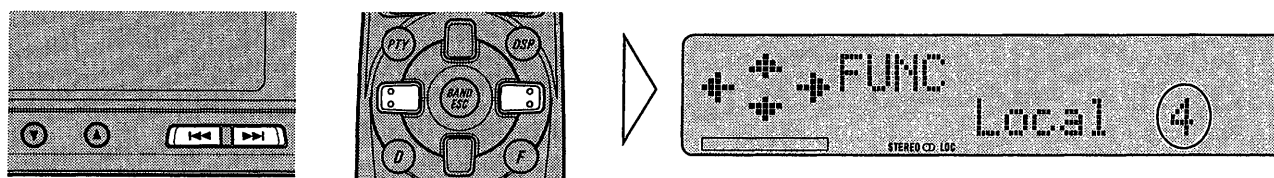

FM : Local 1 ↔ Local 2 ↔ Local 3 ↔ Local 4

MW/LW: Local 1 ↔ Local 2

Note:

- The “Local 4” setting allows reception of only the strongest stations, while lower settings let you receive progressively weaker stations.

To cancel the Function Menu, press the BAND button.

Tuner Operation

Preset Tuning

Up to 18 FM stations (6 in FM1, FM2 and FM3) and 6 MW/LW stations can be stored in memory.

Store the stations in memory under buttons 1–6 beforehand with the BSM (Best Stations Memory) or Preset Memory function.

BSM (Best Stations Memory)

The BSM function stores stations in memory automatically.

1. Select the BSM mode (BSM) in the Function Menu.
2. Switch the BSM mode ON.

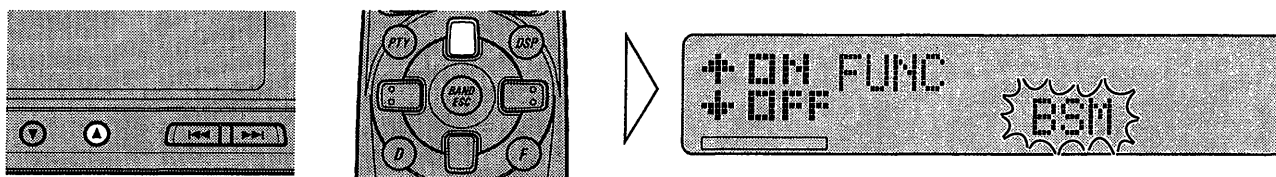

The stations with the strongest signals will be stored under buttons 1–6 and in order of their signal strength.

To cancel the Function Menu, press the BAND button.

- To cancel the process, press the ▼ button in the Function Menu before memorization is complete.

Preset Memory

The Preset Memory function stores stations in memory manually.

1. Select the station whose frequency you want to store in memory.
2. Press one of buttons 1–6 for 2 seconds or longer to store the desired stations. (e.g. Press button 4.)

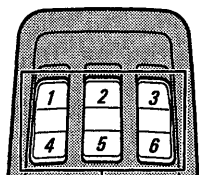

Hold for 2 seconds



The station is stored in memory under the selected button.

Recalling Preset Stations

There are two ways to recall preset stations.

■ Direct Recall

- Press one of buttons 1–6 to recall a station preset under that button. (e.g. Press button 4.)

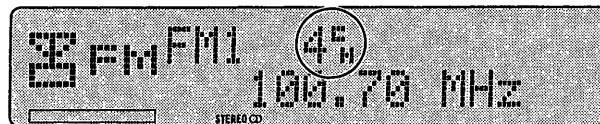

■ Sequential Recall

- Recall a station preset under buttons 1–6.

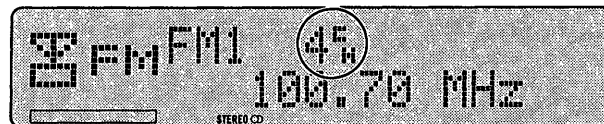
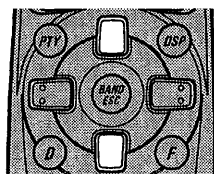
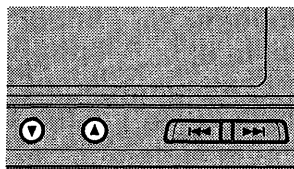

Using the RDS Functions

What is RDS?

RDS (Radio Data System) is a system for transmitting data along with FM programs. This data, which is inaudible, provides a variety of features such as: program service name, program type display, traffic announcement standby, automatic tuning and program type tuning, intended to aid radio listeners in tuning to a desired station.

Note:

- RDS service may not be provided by all stations.
- RDS functions, like AF (Alternative Frequencies search) and TA (Traffic Announcement standby), are only active when your radio is tuned to RDS stations.

Switching the Frequency Display

This unit displays the names (Program Service Name) of networks/stations providing RDS Services and PTY Information. You can also switch from Program Service Name display to frequency display.

- **When you want to know the frequency of the current station, change the display.**

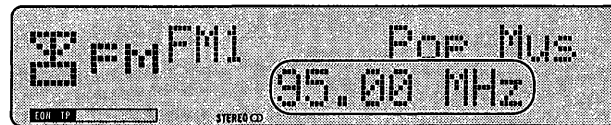
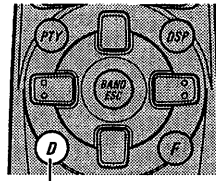

Each press
changes the Display ...

Note:

- After switching displays, if you do not perform an operation within 8 seconds, the Program Service Name is automatically displayed.

PTY Information

PTY (Program Type ID code) information for the currently tuned station appears on the display. The information is correlated with the list in the section "PTY List" on page 25.

Frequency

The frequency of the current station appears on the display.

AF Function

The AF (Alternative Frequencies search) function is used to search for other frequencies in the same network as the currently tuned station. It automatically retunes the receiver to another frequency in the network which is broadcasting a stronger signal when there are problems with reception of the currently tuned station or better reception is possible on a different frequency.

Note:

- AF tunes the receiver only to RDS stations when you use Seek tuning or BSM Auto Memory with the AF Function ON.
- When you recall a preset station, the tuner may update the preset station with a new frequency from the station's AF list. (This is only available when using presets on the FM1 band.) No preset number appears on the display if the RDS data for the station received differs from that for the originally stored station.
- Sound may be temporarily interrupted by another program during an AF frequency search.
- When the tuner is tuned to a non-RDS station, the "AF" indicator flashes. (You can confirm by switching to the Status display. For details, refer to page 98.)
- AF can be switched ON or OFF independently for each FM band.

Activating/Deactivating the AF Function

AF is set to ON by default.

1. **Select the AF mode (AF) in the Function Menu.**
2. **Activate or deactivate AF while in an FM band.**

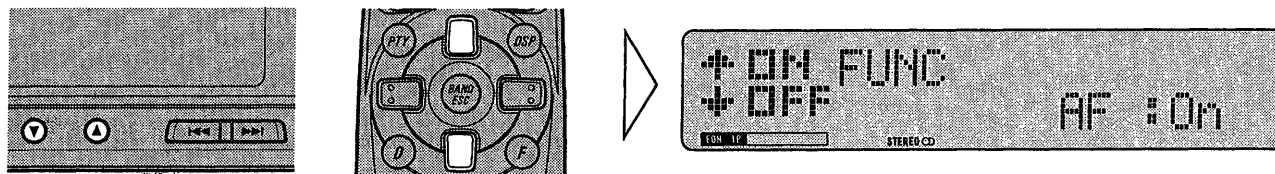

To cancel the Function Menu, press the BAND button.

Using the RDS Functions

PI Seek Function

The tuner searches for another frequency broadcasting the same programming. "Seek" appears on the display and the radio volume is muted during a PI Seek. The muting is discontinued after completion of the PI Seek, whether or not the PI seek was successful. If the PI Seek is unsuccessful, the tuner returns to the previous frequency.

PI Seek

If the tuner fails to locate a suitable alternative frequency or if the broadcasting signal is too weak for proper reception, the PI Seek will automatically start.

Auto PI Seek (for preset station)

When preset stations cannot be recalled, as when traveling long distances, the product can be set to perform PI Seek also during preset recall. The default setting for Auto PI Seek is OFF.

Note:

- Refer to "Initial Setting" for details on how to switch Auto PI Seek ON/OFF.

Regional Function

When AF is used to retune the tuner automatically, Regional (Regional) limits the selection to stations broadcasting regional programs.

Note:

- Regional programming and regional networks are organized differently depending on the country (i.e., they may change according to the hour, state or broadcast area).
- The preset number may disappear on the display if the tuner tunes in a regional station which differs from the originally set station.

Activating the Regional Function

The Regional function can be turned ON independently for each FM band.

1. Select the Regional mode (Regional) in the Function Menu.
2. Activate or deactivate Regional while in an FM band.

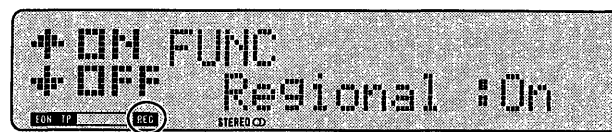
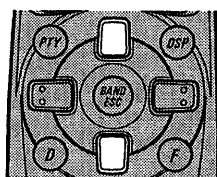
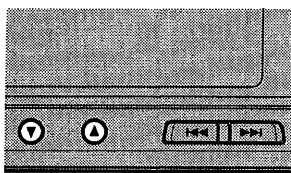

"REG"

To cancel the Function Menu, press the BAND button.

TA Function

The TA (Traffic Announcement standby) function lets you receive traffic announcements automatically, no matter what source (tuner, built-in CD player or multi-CD player) you are listening to. The TA function can be activated for either a TP station (a station that broadcasts traffic information) or an EON TP station (a station carrying information which cross-references TP stations).

Activating/Deactivating the TA Function

1. Tune in a TP or EON TP station.

The "TP" indicator lights when the tuner is tuned to a TP station, and both the "EON" and "TP" indicators light when it is tuned to an EON TP station.

2. Activate the TA function.

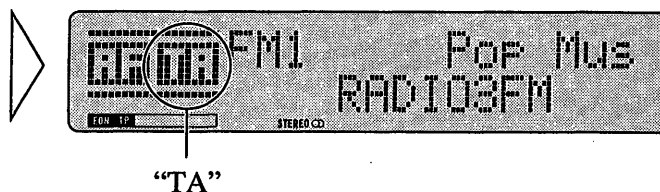
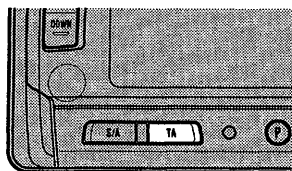

The "TA" indicator lights, indicating that the tuner is waiting for traffic announcements.

Repeat the preceding operation when no traffic announcement is being received to deactivate the TA function.

Note:

- You can also switch the TA Function ON/OFF in the Function Menu.
- The system switches back to the original source following traffic announcement reception.
- The TA function can be activated from the built-in CD player or multi-CD player mode if the tuner was last set to the FM band but not if it was last set to the MW/LW band.
- If the tuner was last set to FM, turning on the TA function lets you operate other tuning functions while listening to a CD.
- Only TP or EON TP stations are tuned in during the Seek Tuning mode when the "TA" indicator is ON.
- Only TP or EON TP stations are stored by BSM when the "TA" indicator is ON.

Using the RDS Functions

Canceling Traffic Announcements

- Press the TA button while a traffic announcement is being received to cancel the announcement and return to the original source.

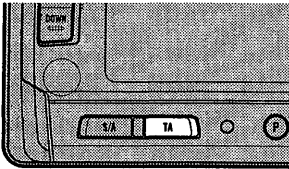

The announcement is canceled but the tuner remains in the TA mode until the TA button is pressed again.

Adjusting the TA Volume

When a traffic announcement begins, the volume adjusts automatically to a preset level to enable you to hear the announcement clearly.

- Set the volume by adjusting it during reception of a traffic announcement.

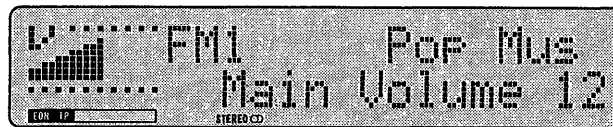
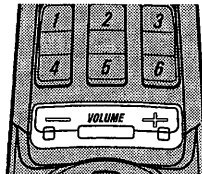
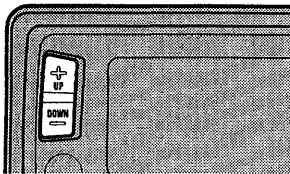

The newly set volume is stored in memory and recalled for subsequent traffic announcements.

TP Alarm Function

About 30 seconds after the "TP" or "EON" indicator is extinguished due to a weak signal, a 5 second beep sounds to remind you to select another TP or EON TP station.

- If you are listening to the tuner, tune in another TP station or EON TP station.

In the built-in CD player or multi-CD player mode, the tuner automatically seeks out the TP station with the strongest signal in the current area 10 (or 30)* seconds after "TP" disappears from the display.

* Time taken before Seek begins.

TA Function ON	10 seconds
TA, AF Functions ON	30 seconds

PTY Function

With Wide and Narrow classification of program type, the PTY function provides two ways to select stations by the type of program being broadcast (PTY Search). It also provides automatic tuning to emergency broadcasts (PTY Alarm).

Note:

- There's no need to perform PTY Search settings again if they have previously been set. After switching to the PTY Search Setting mode in Step 1, just perform PTY Search in Step 4.

Searching the PTY

1. Select the PTY Search Setting mode.

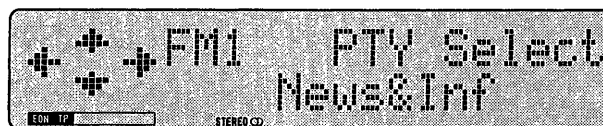
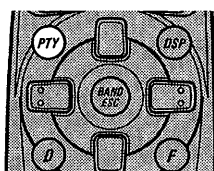
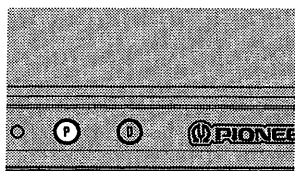

2. Select the PTY Search method (Wide, Narrow).

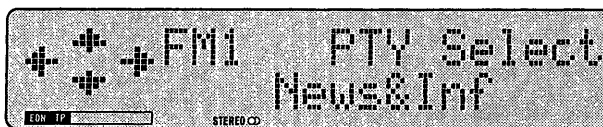
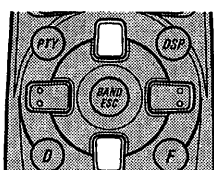
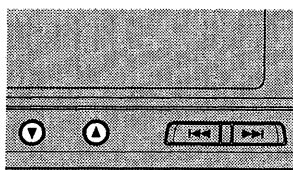

3. Select one from among the PTY.

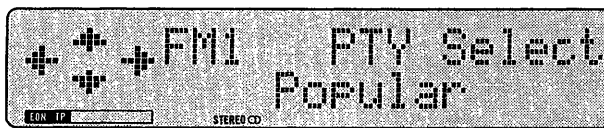
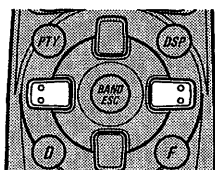
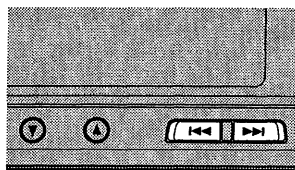

Using the RDS Functions

4. Start PTY Search.

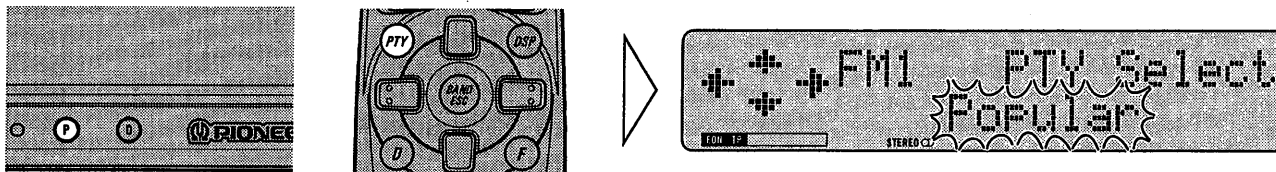

The tuner searches for a station broadcasting the desired PTY.

To cancel the PTY Search Setting mode, hold down the PTY button for 2 seconds or more.

Note:

- If a PTY code of zero is received from a station, "NONE" will be displayed. This indicates that the station has not defined its program contents.
- If the signal is too weak for this product to pick up the PTY code, "NO PTY" will be displayed.
- The program of some stations may differ from that indicated by the transmitted PTY.
- If no station broadcasting the selected programming type is found, "NOT FOUND" is displayed for about 2 seconds, and the tuner returns to the original station.

News Program Interruption Setting

You can switch automatic reception of PTY code news programs ON/OFF. When a received news program ends, reception of the previous program resumes.

- Set interruption to ON or OFF.

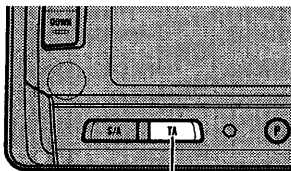

Hold for 2 seconds



PTY Alarm

PTY Alarm is a special PTY code for announcements regarding emergencies such as natural disasters. When the tuner receives the radio alarm code, "ALARM" appears on the display and the volume adjusts to the TA volume. When the station stops broadcasting the emergency announcement, the system returns to the previous source.

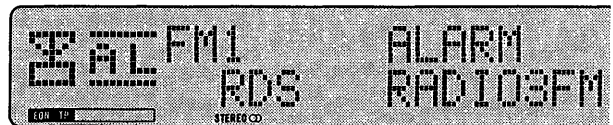

Note:

- The system switches back to the original source following emergency announcement reception.

Canceling Emergency Announcements

- Press the TA button during emergency announcement reception to cancel the announcement and return to the previous source.

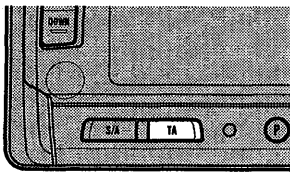

Using the RDS Functions

PTY List

Wide	Narrow	Details
News&Inf	News	News.
	Weather	Weather reports/Meteorological information.
	Affairs	Current affairs.
	Sport	Sports programs.
	Finance	Stock market reports, commerce, trading etc.
	Inf	General information and advice.
Popular	Pop Mus	Popular music.
	Rock Mus	Contemporary modern music.
	Easy Mus	Easy listening music.
	Jazz	Jazz music based programs.
	Oldies	Oldies music, 'Golden age' based programs.
	Folk Mus	Folk music based programs.
	Country	Country music based programs.
	Nat Mus	National music based programs.
	Oth Mus	Other types of music, which can't be categorized.
Classics	L. Class	Light classical music.
	Classic	Serious classical music.
Others	Phone In	Phone in based programs.
	Drama	All radio plays and serials.
	Document	Documentary programs.
	Varied	Light entertainment programs.
	Children	Children's programs.
	Touring	Travel programs, not for announcements about traffic problem.
	Leisure	Programs about hobbies and recreational activities.
	Culture	Programs concerned with any aspect of national or regional culture.
	Religion	Religion affairs programs or services.
	Educate	Educational programs.
	Science	Programs about nature, science and technology.
	Social	Social affairs programs.

Using the Built-in CD Player

Basic Operation of the Built-in CD Player

The built-in CD player plays one standard 12 cm or 8 cm (single) CD at a time. Do not use an adapter when playing an 8 cm CD.

1. Open the front panel and insert the disc with the label side up.

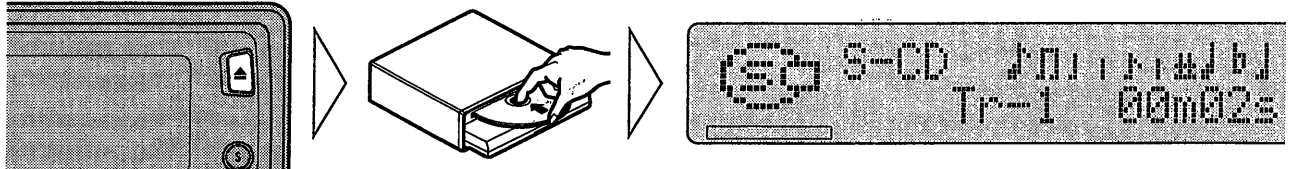

2. Select the desired track (or fast-forward/reverse, per the chart below).

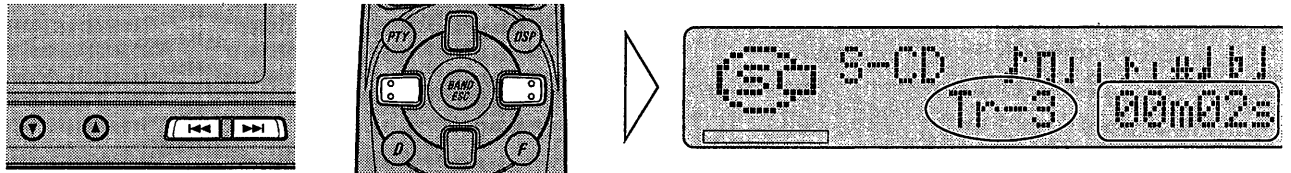

This product's built-in CD player lets you select the Track Search function or Fast-forward/Reverse function by changing the length of time you press the button.

Track Search	0.5 seconds or less
Fast-forward/Reverse	Continue pressing

3. Raise or lower the volume.

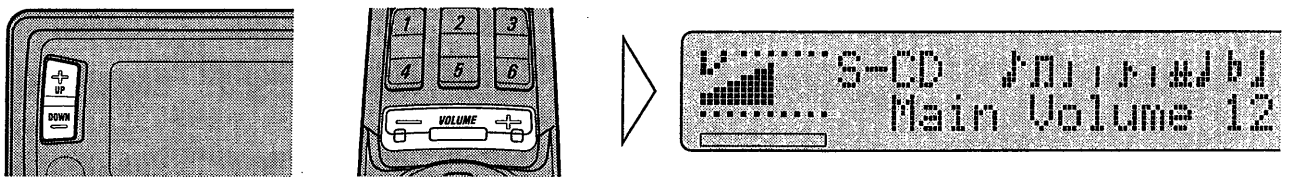

Using the Built-in CD Player

4. Remove the disc.

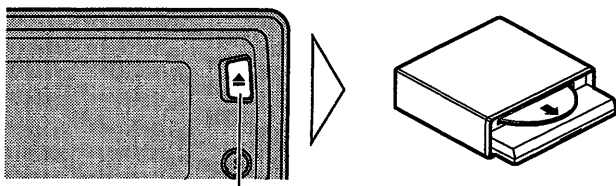

Hold for 2 seconds

Be sure to close the front panel after removing the disc.

Note:

- The CD function can be turned ON/OFF with the disc remaining in this product. (See page 11.)
- Discs left partially inserted after ejection may incur damage or fall out.
- If a disc cannot be inserted fully or playback fails, make sure the recorded side is down, hold down the OPEN/EJECT button for 2 seconds or more and check the disc for damage before reinserting it.
- If the built-in CD player cannot operate properly, an error message (such as "ERROR-14") appears on the display. Refer to "Built-in CD Player Troubleshooting" on page 33.

Switching the Display (only for CD TEXT Discs)

You can use this function when playing a CD TEXT disc.

Note:

- A CD TEXT disc is a CD featuring recorded text information such as Disc Title, Artist Name and Track Title.

Selecting the Display

- Select the desired display.

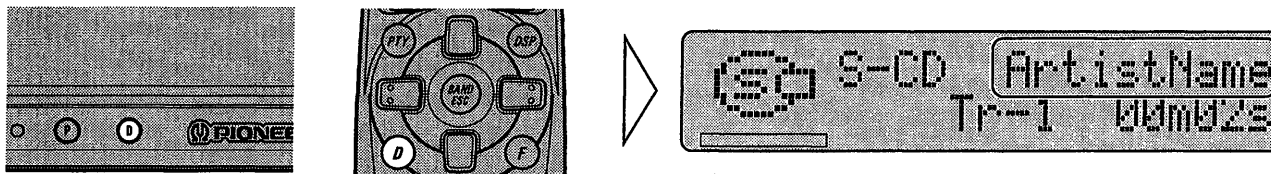

Each press of the DISPLAY button changes the display in the following order:

Disc Title → Artist Name → Track Title

Scrolling the Display

This unit displays the first 10 letters only of Disc Title, Artist Name and Track Title. With text longer than 10 letters, you can see the rest of the text by scrolling.

- **Scroll the display.**

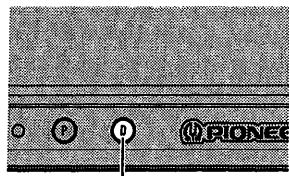

Hold for 2 seconds

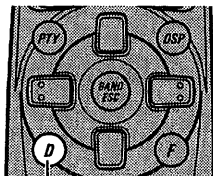

Hold for 2 seconds

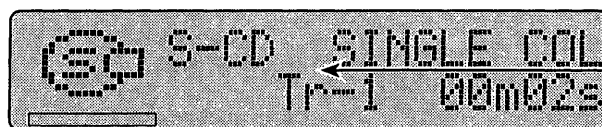

Note:

- You cannot input a disc title with a CD TEXT disc.

Entering the Function Menu

In this menu you can select built-in CD player functions.

- **Select the desired mode in the Function Menu.**

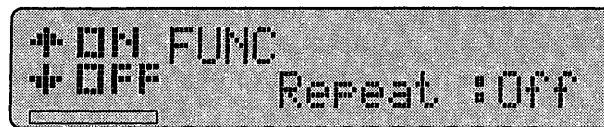
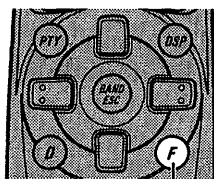

Each press
changes the Mode ...

Each press of the FUNCTION button selects the mode in the following order:

Repeat → Random → Scan → Pause → COMP&DBE

To cancel the Function Menu, press the BAND button.

Note:

- After entering the Function Menu, if you do not perform an operation within about 30 seconds, the Function Menu is automatically canceled.

Using the Built-in CD Player

Entering the Detailed Setting Menu

In this menu you can perform Disc Title Input and PGM button settings.

- **Enter the Detailed Setting Menu.**

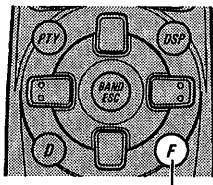

Hold for 2 seconds

Each press of the FUNCTION button selects the mode in the following order:

TitleInput* → PGM-key

* During play of a CD TEXT disc, you cannot switch to the "TitleInput" mode.

To cancel the Detailed Setting Menu, press the BAND button.

Note:

- You can cancel the Detailed Setting Menu by pressing the FUNCTION button again for 2 seconds or more.

Repeat Play

Repeat Play plays the same track repeatedly.

1. **Select the Repeat mode (Repeat) in the Function Menu.**
2. **Switch the Repeat Play ON or OFF.**

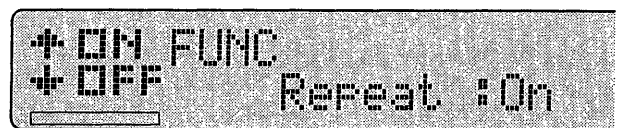
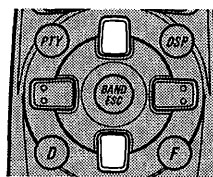
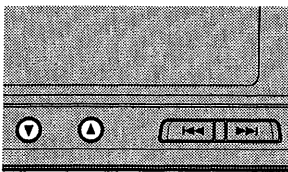

To cancel the Function Menu, press the BAND button.

Note:

- If you perform Track Search or Fast-forward/Reverse, Repeat Play is automatically canceled.

Random Play

Random Play plays the tracks on a CD in random order for variety.

1. Select the Random mode (Random) in the Function Menu.
2. Switch the Random Play ON or OFF.

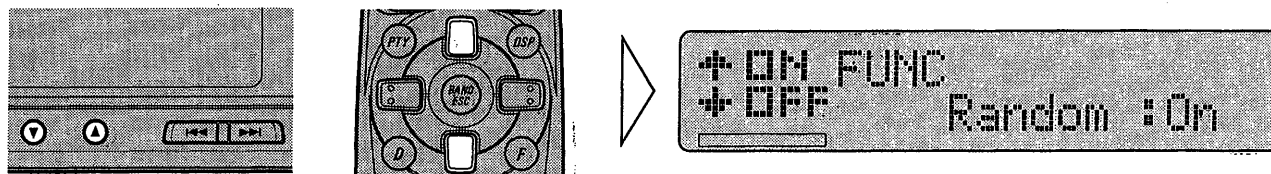

To cancel the Function Menu, press the BAND button.

Note:

- Since playback is random, the same track may be repeated consecutively.

Scan Play

Scan Play plays the first 10 seconds or so of each track on a CD in succession.

1. Select the Scan mode (Scan) in the Function Menu.
2. Switch the Scan Play ON.

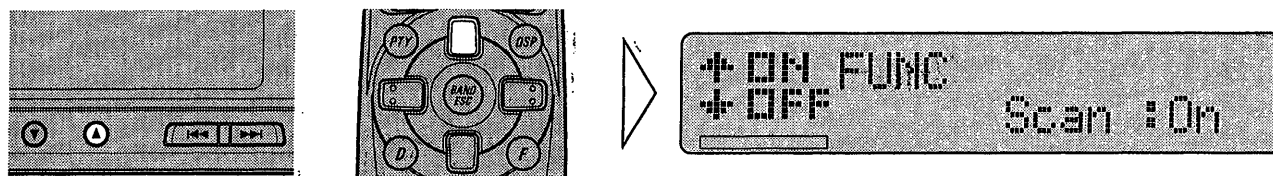

3. When you hear the track you are looking for, cancel Scan Play.

If the Function Menu is automatically canceled at this time, select the Scan mode in the Function Menu once more.

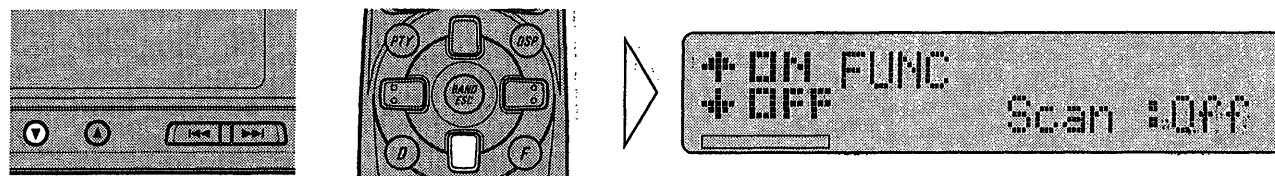

Playback of the current track continues.

To cancel the Function Menu, press the BAND button.

Note:

- Scan Play is canceled automatically after all the tracks on a disc have been scanned.

Using the Built-in CD Player

Pause

1. Select the Pause mode (Pause) in the Function Menu.
2. Stop playback temporarily or restart the system.

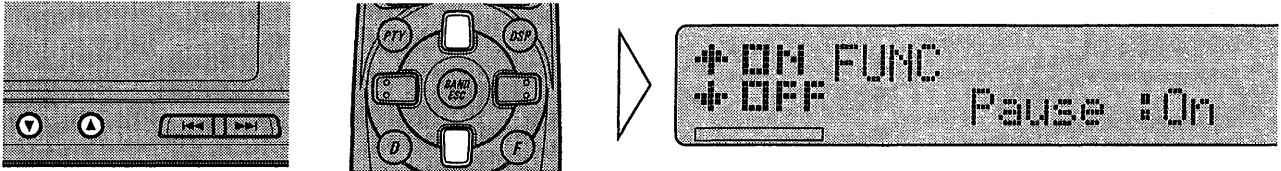

To cancel the Function Menu, press the BAND button.

CD Sound Quality Adjustment

COMP (Compression) and DBE (Dynamic Bass Emphasis) functions are available to adjust the sound quality of your multi-CD player. Each can be adjusted in two levels, but they cannot be used together.

■ COMP

The COMP (Compression) function eliminates distortion caused by an imbalance between loud and subdued sounds at higher volumes.

■ DBE

DBE (Dynamic Bass Emphasis) boosts bass level to give a fuller sound.

COMP/DBE ON/OFF Switching

1. Select the COMP/DBE switching mode (COMP&DBE) in the Function Menu.
2. Select the desired mode in the following order:

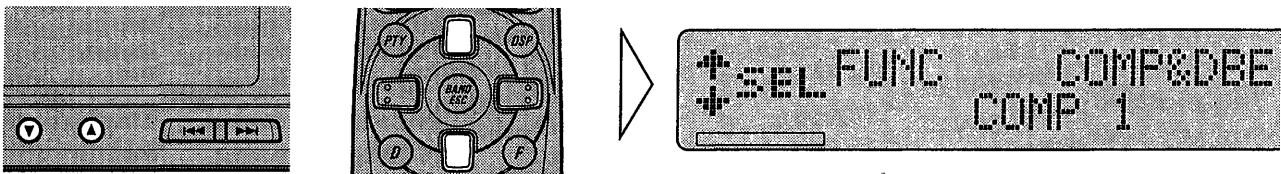

COMP OFF → COMP 1 → COMP 2 → COMP OFF → DBE 1 → DBE 2

To cancel the Function Menu, press the BAND button.

Disc Title Input

The built-in CD player's Disc Title Input function permits entry of up to 100 disc titles comprising up to 10 characters when one or more multi-CD players is installed. (See "Disc Title Input" on page 45 under "Using Multi-CD Players".)

Note:

- During "CD TEXT" reproduction, you cannot switch to this mode.

Disc Selection and Care

- Play only CDs bearing the Compact Disc Digital Audio mark.



Note:

- A CD TEXT disc is a CD featuring recorded text information such as Disc Title, Artist Name and Track Title. If a CD features the top right mark on its disc title side, that disc is a CD TEXT disc. (There are also some CD TEXT discs that do not feature the top right mark.)
- Check all CDs before playing, and discard cracked, scratched or warped discs.

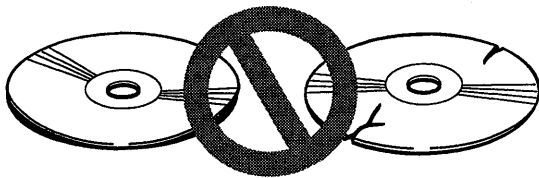

- Wipe dirty or damp discs outward from the center with a soft cloth.

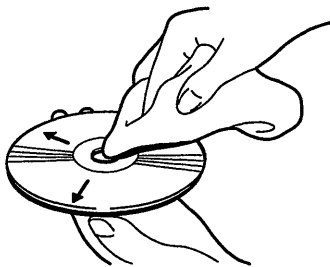

- Avoid touching the recorded (iridescent) surface when handling discs.
- Store discs in their cases when not in use.

Precaution

- Keep discs out of direct sunlight and high temperatures.
- Do not affix labels or apply chemicals to discs.
- Condensation may collect inside the player when using the heater in cold weather, interfering with playback. Turn it off for an hour or so and wipe damp discs with a soft cloth.
- Road shocks may interrupt CD playback.

Built-in CD Player Troubleshooting

Error Message

When problems occur with CD playback, an error message appears on the display. Refer to the table below to identify the problem, then take the suggested corrective action. If the error persists, contact your dealer or your nearest PIONEER Service Center.

Message	Possible cause	Recommended action
ERROR- 11, 12, 17, 30	Dirty disc.	Clean the disc.
ERROR- 11, 12, 17, 30	Scratched disc.	Replace the disc.
ERROR- 14	Unrecorded CD.	Check the disc.
ERROR- 10, 11, 12, 14, 17, 30, A0	Electrical or mechanical problem.	Turn the ignition ON and OFF, or switch to a different source, then back to the CD player.
HEAT	CD player overheating.	Discontinue play until the machine temperature drops.

Using Multi-CD Players

This product can control one or more multi-CD players. (There are some types of Multi-CD players such as the "CDX-P630S" which enable connection of a single unit only.)

Basic Operation of Multi-CD Players

1. Select the multi-CD player source.

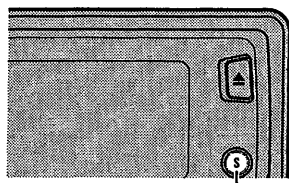

Each press changes the Source ...

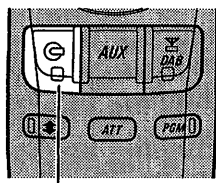

Each press changes the Source ...

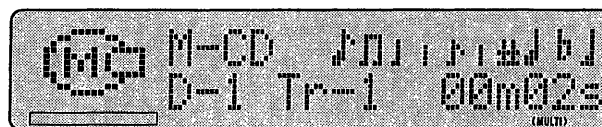

Note:

- The multi-CD player may perform a preparatory operation, such as verifying the presence of a disc or reading disc information, when the power is turned ON or a new disc is selected for playback. "READY" is displayed.
- If the multi-CD player cannot operate properly, an error message such as "ERROR-14" is displayed. Refer to the multi-CD player owner's manual.
- If there are no discs in the multi-CD player magazine, "NO DISC" is displayed.

2. Select the desired disc.

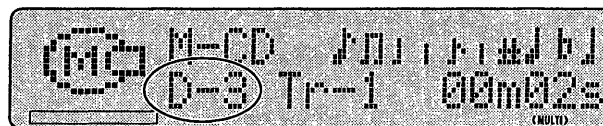
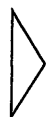
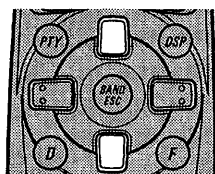
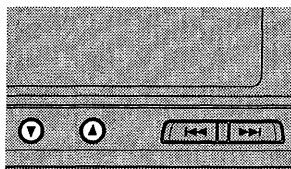

3. Select the desired track (or fast-forward/reverse, per the chart below).

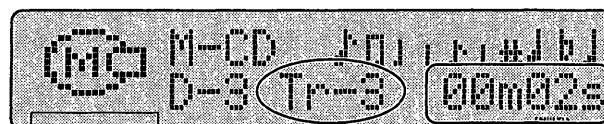
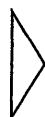
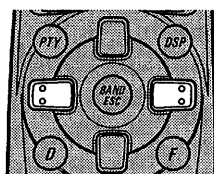
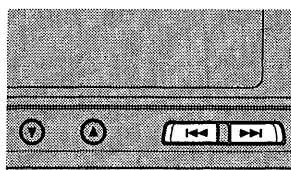

This product lets you select the track search function or fast-forward/reverse function by changing the length of time you press the button.

Track search	0.5 seconds or less
Fast-forward/Reverse	Continue pressing

Using Multi-CD Players

1. Press the appropriate button from 1–5 to select the block containing the desired disc. (e.g. Press button 4.)

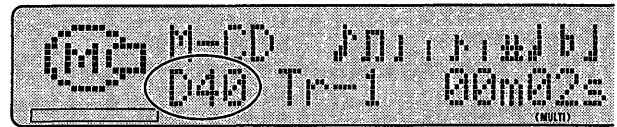
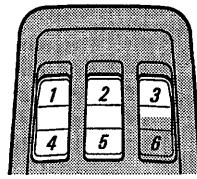

2. Select the desired disc.

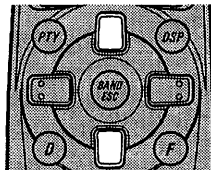
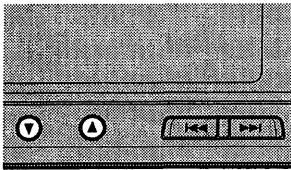

Entering the Function Menu

In this menu you can select Multi-CD Player functions.

- Select the desired mode in the Function Menu.

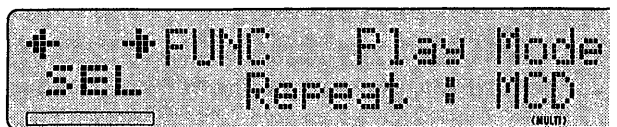
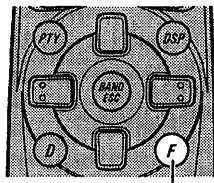

Each press
changes the Mode ...

Each press of the FUNCTION button selects the mode in the following order:

Repeat → ListSearch → ABC-Search* → Random → Scan → ITS-Play
→ Music Group* → Frequent* → Pause → COMP&DBE

* ABC-Search, Music Group and Frequent are 50-Disc type multi-CD player functions. You cannot switch to these modes when using 6-Disc and 12-Disc type multi-CD players.

To cancel the Function Menu, press the BAND button.

Note:

- With multi-CD players that do not feature COMP (Compression) and DBE (Dynamic Bass Emphasis) functions, "NO COMP" is displayed if you switch to the COMP mode.
- After entering the Function Menu, if you do not perform an operation within about 30 seconds, the Function Menu is automatically canceled.

Entering the Detailed Setting Menu

In this menu you can perform Disc Title Input, ITS Program, Music Group Input and PGM button settings.

- **Enter the Detailed Setting Menu.**

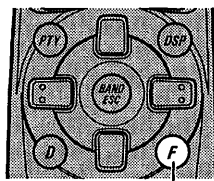

Hold for 2 seconds



Each press of the FUNCTION button selects the mode in the following order:

TitleInput → ITS → MG Input* → PGM-key

* MG Input is a 50-Disc type multi-CD player function. You cannot switch to this mode when using 6-Disc and 12-Disc type multi-CD players.

To cancel the Detailed Setting Menu, press the BAND button.

Note:

- You can cancel the Detailed Setting Menu by pressing the FUNCTION button again for 2 seconds or more.

Pause

1. **Select the Pause mode (Pause) in the Function Menu.**
2. **Stop playback temporarily or restart the system.**

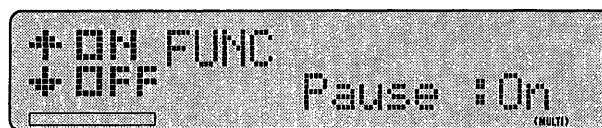
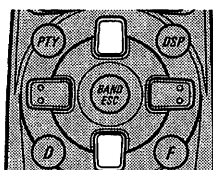
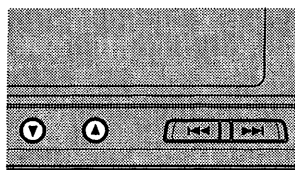

To cancel the Function Menu, press the BAND button.

Using Multi-CD Players

CD Sound Quality Adjustment

COMP (Compression) and DBE (Dynamic Bass Emphasis) functions are available to adjust the sound quality of your multi-CD player. Each can be adjusted in two levels, but they cannot be used together.

COMP and DBE can also be used with another multi-CD player which is equipped with these functions. If it is not so equipped, "NO COMP" is displayed when COMP/DBE switching is attempted.

■ COMP

The COMP (Compression) function eliminates distortions caused by an imbalance between loud and subdued sounds at higher volumes.

■ DBE

DBE (Dynamic Bass Emphasis) boosts bass levels to give fuller sounds.

COMP/DBE ON/OFF Switching

1. Select the COMP/DBE switching mode (COMP&DBE) in the Function Menu.
2. Select the desired mode in the following order:

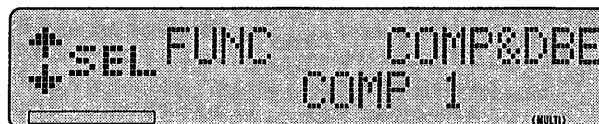
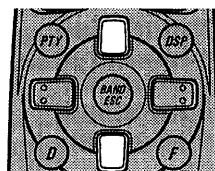
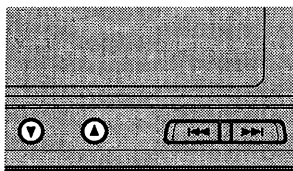

COMP OFF → COMP 1 → COMP 2 → COMP OFF → DBE 1 → DBE 2

To cancel the Function Menu, press the BAND button.

Multi-CD Player Repeat Modes

Multi-CD players offer four repeat modes: One-track Repeat, Disc Repeat, Multi-CD player Repeat and All Repeat. Multi-CD player Repeat is the default mode (normal play) when one or more multi-CD players is installed.

1. Select the Repeat Selecting mode (Repeat) in the Function Menu.
2. Select the desired repeat mode in the following order:

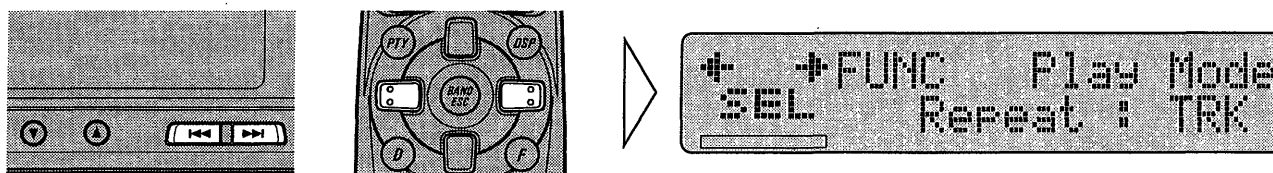

Multi-CD player Repeat (“MULTI” indicator lights) → ALL Repeat (Nothing) → One-track Repeat (“Repeat” is displayed) → Disc Repeat (“Repeat” is displayed and “DISC” indicator lights)

To cancel the Function Menu, press the BAND button.

Note:

- All Repeat is available only when two or more multi-CD players are installed.

Multi-CD Player Repeat Modes

Mode	Operation
One-track Repeat	Plays current track repeatedly. <ul style="list-style-type: none"> • When Track Search or fast forward/reverse is performed, the mode returns to the Disc Repeat mode. • When a different disc or multi-CD player is selected, the mode switches to the Multi-CD player Repeat mode.
Disc Repeat	Plays current disc repeatedly. <ul style="list-style-type: none"> • When a different disc or multi-CD player is selected, the mode switches to the Multi-CD player Repeat mode.
Multi-CD player Repeat (normal play)	Plays all discs loaded in the multi-CD player magazine repeatedly in order, starting with the first disc.
All Repeat	Plays all discs in the magazines of all multi-CD players in order.

Using Multi-CD Players

Multi-CD Player Random Play

1. Select the Random mode (Random) in the Function Menu.
2. Switch the Random Play ON or OFF.

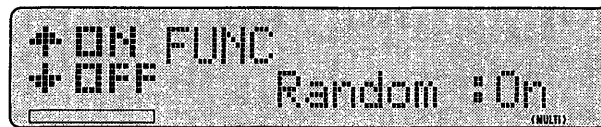
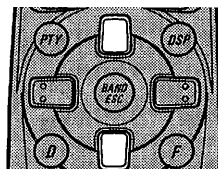
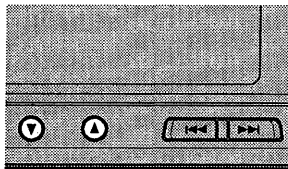

When Multi-CD Player Random Play is ON, you can combine it with Repeat Mode to operate as shown below. Switching the Repeat Mode switches Random Play OFF.

To cancel the Function Menu, press the BAND button.

Note:

- Since playback is random, the same track may be repeated consecutively.

■ Multi-CD Player Random Play Options

Mode	Operation
One-track Repeat	The mode returns to the Disc Repeat mode, and all tracks on the current disc are played randomly.
Disc Repeat "Random" + "DISC"	All tracks on the current disc are played randomly.
Multi-CD player Repeat "Random" + "MULTI"	All tracks on the discs in the multi-CD player magazine are played randomly.
All Repeat "Random"	All tracks on the discs in all the multi-CD players are played randomly.

Multi-CD Player Scan Play

When one or more multi-CD players are installed, the first 10 seconds or so of each track on a disc are scanned in the One-track Repeat and Disc Repeat modes and the first tracks of each disc in the multi-CD player Repeat and All Repeat modes.

1. Select the Scan mode (Scan) in the Function Menu.

2. Switch the Scan Play ON.

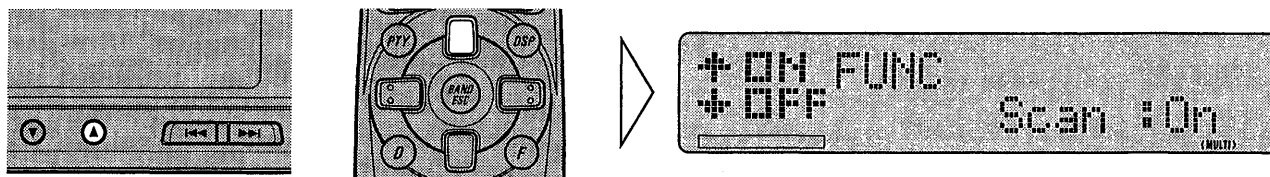

When multi-CD player Scan Play is switched ON and combined with the Repeat Mode, it operates as shown in the following chart. If the Repeat Mode is switched, Scan Play switches OFF.

3. When you hear the track you are looking for, cancel Scan Play.

If the Function Menu has been canceled automatically, select the Scan mode in the Function Menu again.

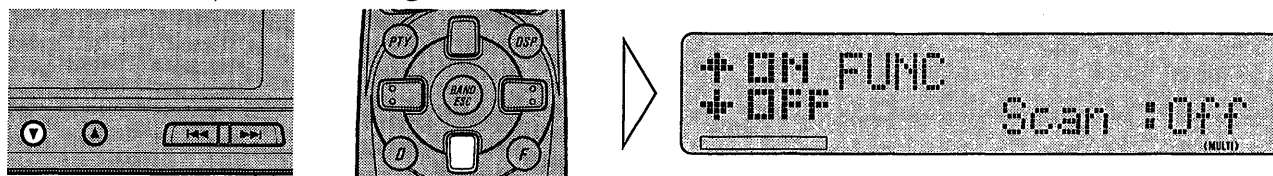

Playback of the current track or disc will continue.

To cancel the Function Menu, press the BAND button.

Note:

- Scan Play is canceled automatically after all the tracks or discs have been scanned.

■ Multi-CD Player Scan Play Options

Mode	Operation
One-track Repeat	The mode returns to the Disc Repeat mode, and all tracks on the current disc are scanned.
Disc Repeat "Scan" + "DISC"	All tracks on the current disc are scanned.
Multi-CD player Repeat "Scan" + "MULTI"	The first tracks of all the discs in the multi-CD player magazine are scanned.
All Repeat "Scan"	The first tracks of all the discs in the magazines of all the installed multi-CDs are scanned.

ITS (Instant Track Selection)

The ITS function allows you to search for the track you wish to play when one or more multi-CD players are installed. You can use ITS to program automatic playback of up to 24 tracks per disc from up to 100 discs. (You can store ITS program and Disc Title data for up to 100 discs in memory. With a 50-Disc type multi-CD player, you can also store Music Group data.)

Using Multi-CD Players

ITS Programming

ITS programming can be conducted in any multi-CD player playback mode except ITS playback.

1. Play the track you wish to program.
2. Select the ITS Programming mode (ITS) in the Detailed Setting Menu.
3. Program the desired track.

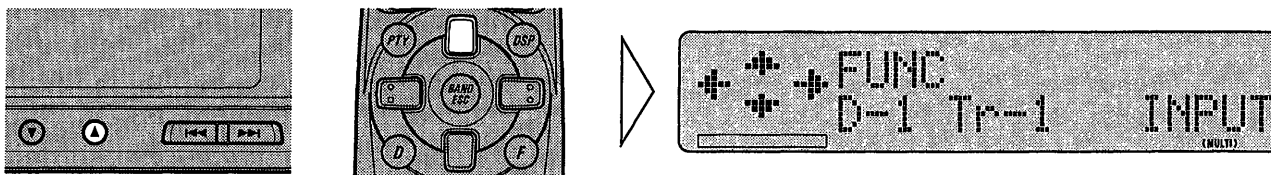

To cancel the Detailed Setting Menu, press the BAND button.

Note:

- After 100 discs have been programmed, data for a new disc will overwrite the data for the disc that has not been played back for the longest time.

ITS Playback

ITS playback can be performed in any repeat mode.

1. Select the ITS Playback mode (ITS-Play) in the Function Menu.
2. Switch the ITS Playback ON or OFF.

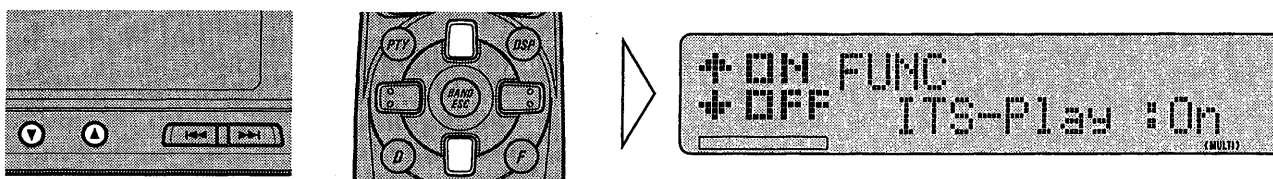

When ITS Play is ON, you can combine it with Repeat Mode to operate as shown below. If you change Repeat Mode into One-track Repeat, ITS Play will be turned OFF.

The ITS programmed tracks are played back in order from first to last.

To cancel the Function Menu, press the BAND button.

Note:

- If no track in the current range is programmed for ITS playback, "ITS EMPTY" is displayed.

■ Multi-CD Player ITS Play

Mode	Operation
One-track Repeat	The mode returns to the Disc Repeat mode and all programmed tracks on the current disc are played.
Disc Repeat "ITS" + "DISC"	All programmed tracks on the current disc are played.
Multi-CD player Repeat "ITS" + "MULTI"	All programmed tracks on the discs in the multi-CD player magazine are played back. <ul style="list-style-type: none"> • If there are no programmed tracks on the current disc, ITS advances to the next disc.
All Repeat "ITS"	The programmed tracks on all the discs in the magazines of all the installed multi-CD are played back. <ul style="list-style-type: none"> • If there are no programmed tracks on the current disc (or multi-CD player), ITS advances to the next disc (or multi-CD player).

Erasing ITS Programs

ITS programs for up to 100 discs are stored permanently until you erase them.

■ Erase a Track Program

1. Select the track you wish to erase, during ITS playback.
2. Select the ITS Programming mode (ITS) in the Detailed Setting Menu.
3. Erase the track program.

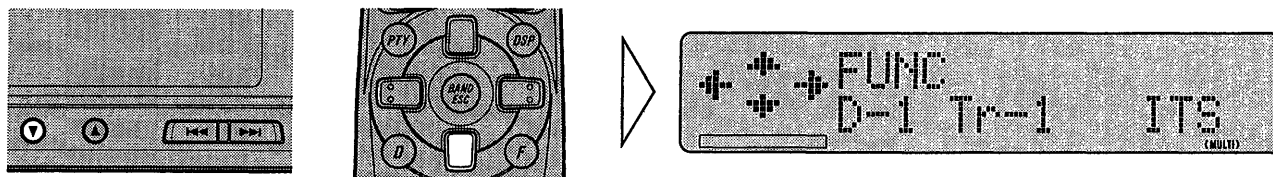

ITS is canceled and playback of the next ITS-programmed track begins. If there are no more programmed tracks in the current range, "ITS EMPTY" is displayed and normal playback resumes.

To cancel the Detailed Setting Menu, press the BAND button.

Using Multi-CD Players

■ Erase a Disc Program

1. Select the disc you wish to erase, while the disc is playing.
2. Select the ITS Programming mode (ITS) in the Detailed Setting Menu.
3. Erase the disc program.

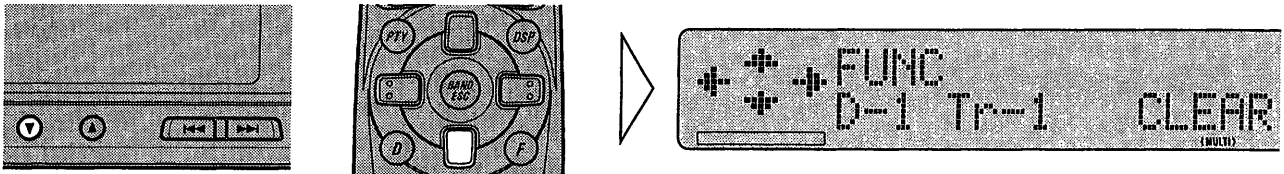

To cancel the Detailed Setting Menu, press the BAND button.

Disc Title Input

You can input Titles up to 10 characters long for up to 100 discs. Using this function lets you easily search for and select a desired disc for play. (You can store ITS program and Disc Title data for up to 100 discs in memory. With a 50-Disc type multi-CD player, you can also store Music Group data.)

1. Play the disc you wish to input the disc title.
2. Select the Disc Title Input mode (TitleInput) in the Detailed Setting Menu.
3. Switch the Alphabet modes.

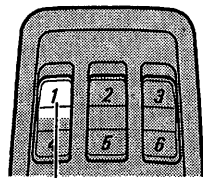

Each press
changes the Mode ...



Each press of the button 1 changes the mode in the following order:

Alphabet (Upper case), Numbers and Symbols → Alphabet (Lower case)
→ European letters, such as those with accents (e.g. á, à, ä, ç)

Note:

- You can switch to the Numbers and Symbol mode by pressing button 2.

4. Select a letter, number or symbol.

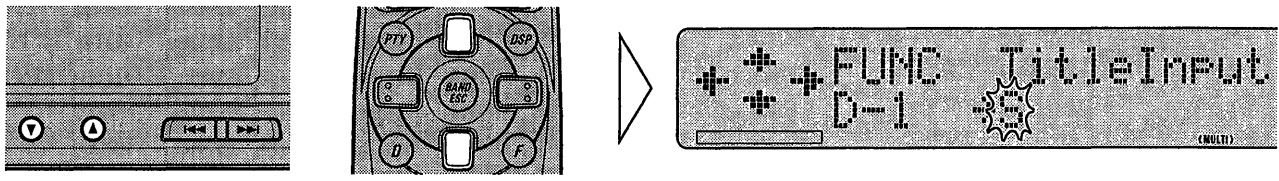

To insert a space, select the flashing cursor.

5. Reverse or advance box by box.

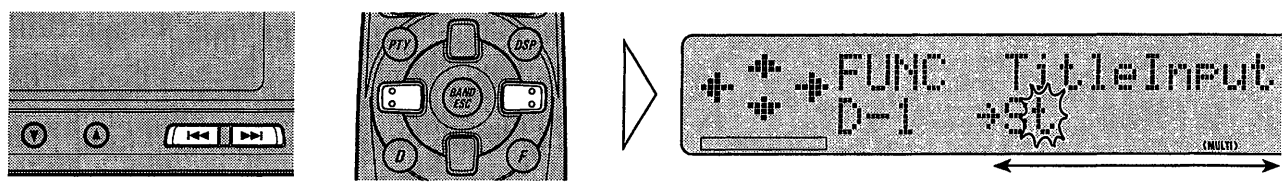

6. When the title is completed, store it in memory to make the flashing cursor fade out.

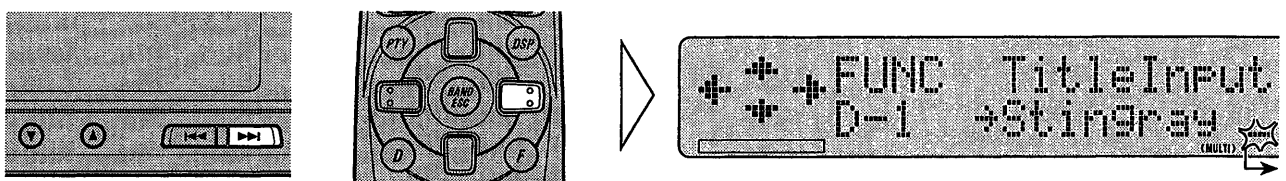

To cancel the Detailed Setting Menu, press the BAND button.

Note:

- Titles remain in memory, even after the disc has been removed from the magazine, and are recalled when the disc is reinserted.
- After the titles for 100 discs have been entered, data for a new disc will overwrite the data for the disc that has not been played back for the longest time.

Using Multi-CD Players

Selecting Discs by Disc Title List

Follow the procedures below to play a disc for which you have input the title in a multi-CD player:

1. **Select the Disc Title List mode (ListSearch) in the Function Menu.**
2. **Each time you press the ◀ or ▶ button, titles in the current disc magazine are displayed in the order of their disc numbers.**

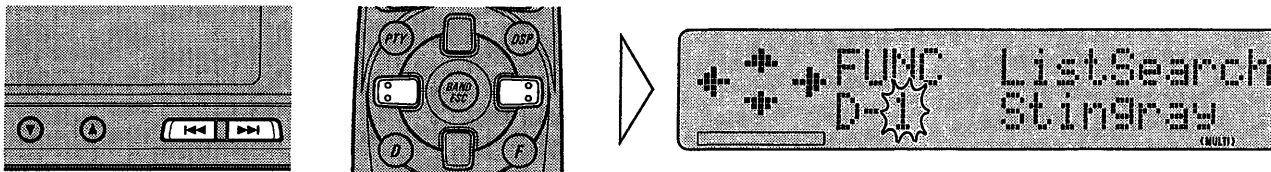

Nothing is displayed for discs whose titles have not been input.

3. **Select the desired disc for playback by pressing the ▲ button when its title is displayed.**

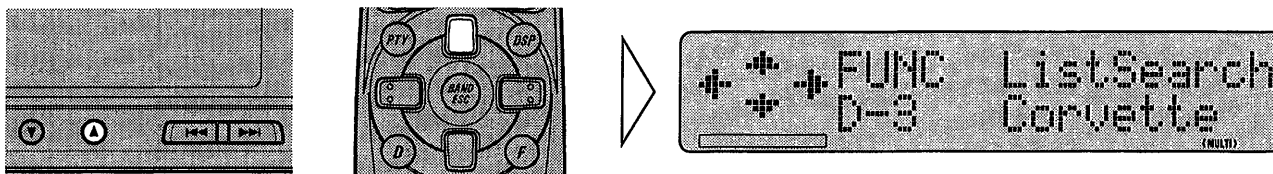

To cancel the Function Menu, press the BAND button.

Selecting Discs Using "ABC" Disc Title Search (for 50-Disc type only)

You can search for and select a disc by searching for the first letter of the desired disc's Disc Title.

1. Select the "ABC" Disc Title Search mode (ABC-Search) in the Function Menu.
2. Select the desired first letter.

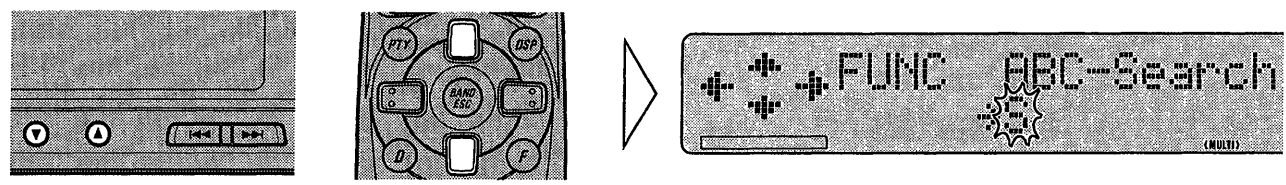

3. Select the desired disc title.

Each time you press the button, titles with the selected first letter are displayed in the order of their disc numbers.

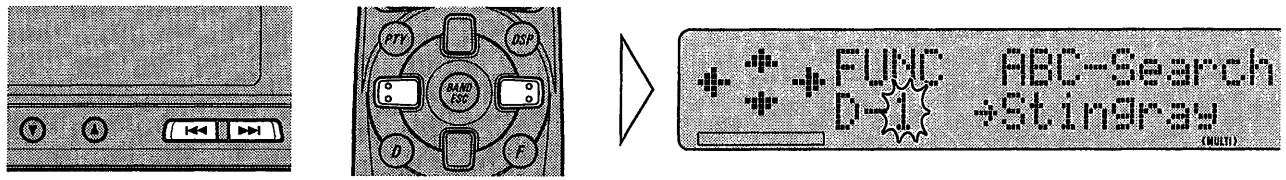

Note:

- When there are no disc titles starting with the letter you selected, "NO TITLE" is displayed.
- Press the ▼ button to return to selection of the first letter.

4. Select the desired disc for playback by pressing the ▲ button when its title is displayed.

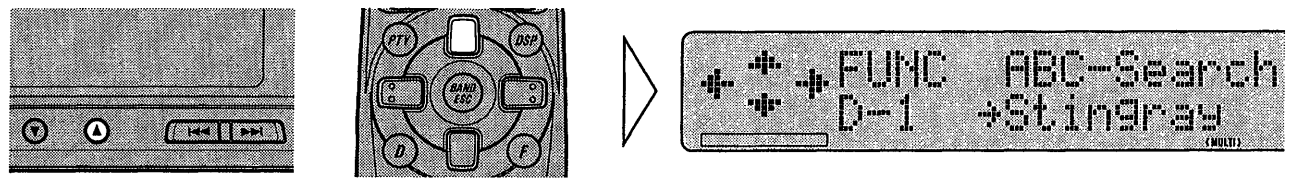

To cancel the Function Menu, press the BAND button.

Using Multi-CD Players

Music Group Play (for 50-Disc type only)

The Music Group Play function classifies discs loaded in a 50-Disc type multi-CD player into 10 groups, and plays only discs from the same group. Up to 100 discs can be classified into groups. (Music Group, ITS program and Disc Title data for up to 100 discs can be stored in memory.)

Note:

- Music Group types are as follows:
ROCK 1, ROCK 2, POP, JAZZ, INSTRMNT, CLASSIC, GROUP 1, GROUP 2, GROUP 3, GROUP 4

Classifying a Disc into a Group

1. Play the disc you want to classify into a group.
2. Select the Music Group Input mode (MG Input) in the Detailed Setting Menu.
3. Select the desired group.

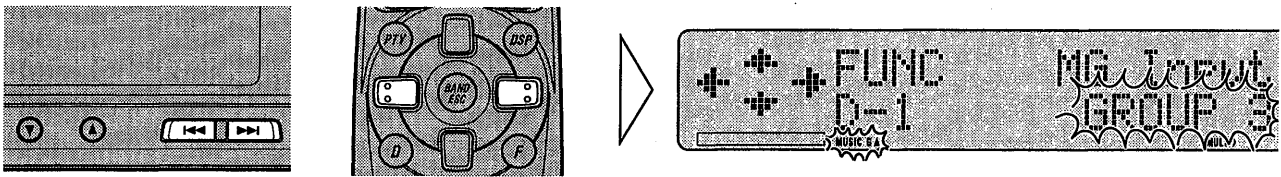

4. Register the disc in the selected group.

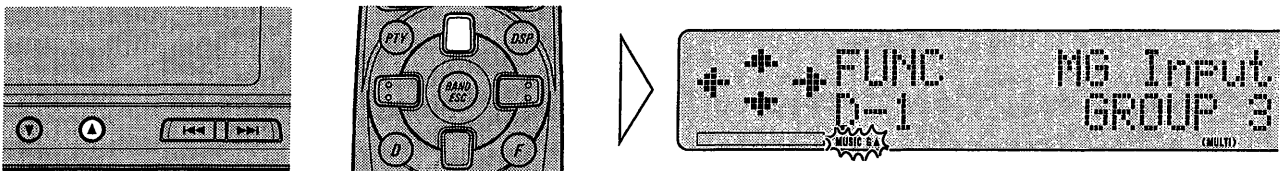

To cancel the Detailed Setting Menu, press the BAND button.

Note:

- Even if you remove a disc from a magazine after you have registered it in a group, its assigned group is stored in memory. This means that when you reinsert the disc in the magazine, there's no need to reassign it to the group.
- After assigning 100 discs to groups, data input for a new disc overwrites data for the disc that has been played least recently.

Music Group Playback

Only discs in the same group are played.

1. Select the Music Group Playback mode (Music Group) in the Function Menu.
2. Select the desired Music Group.

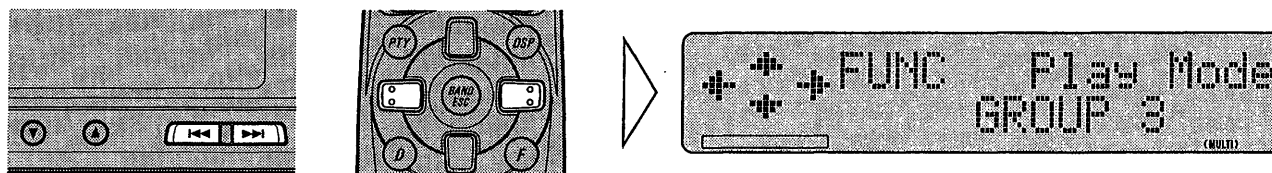

Note:

- At first, the group of the disc playing is displayed. If the disc playing does not belong to a group, "NO GROUP" is displayed.

3. Switch music group playback ON or OFF.

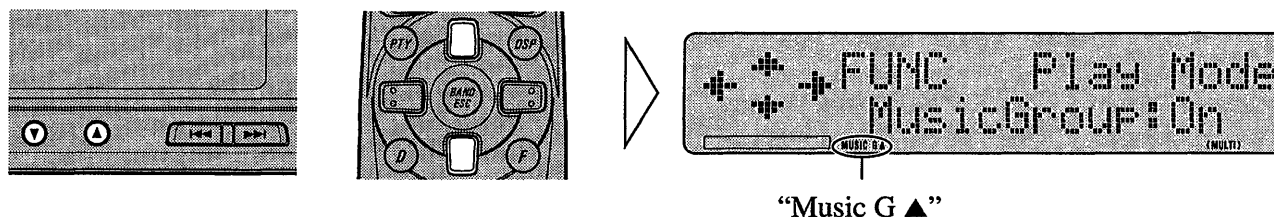

To cancel the Function Menu, press the BAND button.

Note:

- If there are no discs registered in the selected group, "MG EMPTY" is displayed.

Deleting a Disc from a Music Group

1. Play the disc you want to delete from a group.
2. Select the Music Group Input mode (MG Input) in the Detailed Setting Menu.
3. Delete the disc from the group.

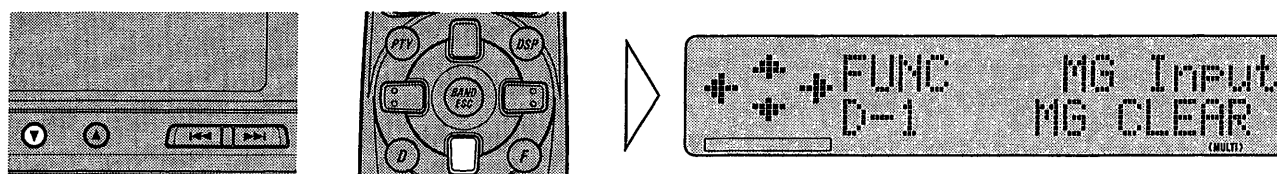

To cancel the Detailed Setting Menu, press the BAND button.

Note:

- During music group playback, if you have deleted the disc currently playing from the group, the next disc in the group is played. If all discs in the same group have been deleted, "NO GROUP" is displayed.

Using Multi-CD Players

Displaying Disc Title or Music Group (for 50-Disc type only)

You can display the Disc Title or Music Group of the disc playing.

- **Select the desired display.**

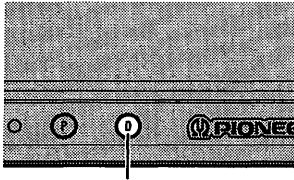

Each press
changes the Display ...

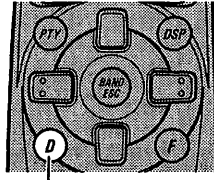

Each press
changes the Display ...

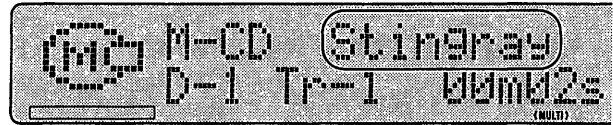

Each press of the DISPLAY button changes the display in the following order:

Disc Title → Music Group

Note:

- When playing a disc that does not have a title, if you switch to Disc Title display, "No Title" flashes for 4 seconds, and then the display returns to the previous indications.
- When playing a disc that doesn't belong to a group, if you select Music Group display, "NO GROUP" flashes for 4 seconds, and then the display returns to the previous indications.

Frequency Play (for 50-Disc type only)

The Frequency Play Function plays discs in order, from the most frequently played disc to the least frequently played disc, or vice versa.

1. **Select the Frequency Playback mode (Frequent) in the Function Menu.**
2. **Select the desired play order.**

For play of discs in order starting with the most frequently played disc, select "Most". For play of discs in order starting with the least frequently played disc, select "Least".

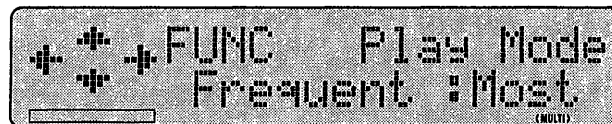
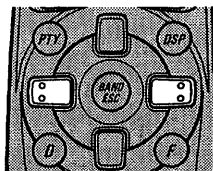
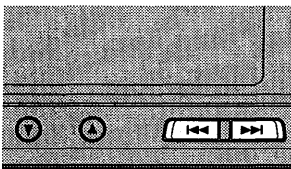

3. Switch Frequency playback ON or OFF.

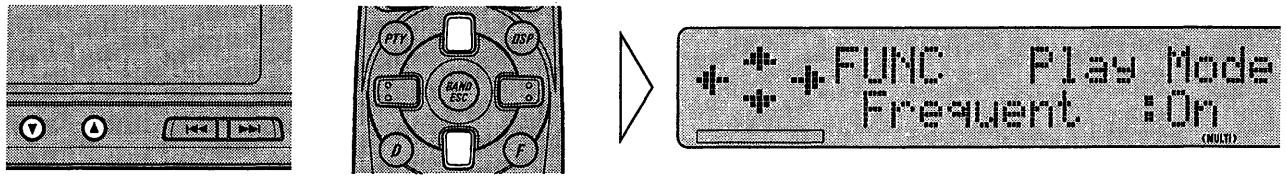

To cancel the Function Menu, press the BAND button.

Note:

- During Frequency Playback, pressing the ▲ or ▼ button changes to the previous or next disc in the frequency order.

Ejecting a Single Disc (for 50-Disc type only)

This function lets you eject discs one at a time from a 50-Disc multi-CD player .

1. Play the disc you want to eject.
2. Move the disc to the extra tray.

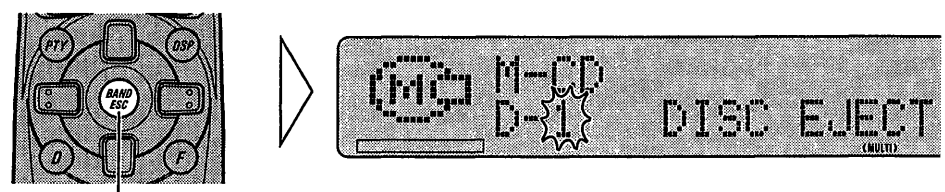

Hold for 2 seconds

3. Remove the disc from the extra tray.

(Refer to the 50-Disc type multi-CD player's owner's manual.)

Note:

- This function does not operate if a disc is already loaded in the extra tray.

Using the Digital Signal Processor (DSP)

This unit features two DSP modes: the PRO mode and the STD mode. You can switch between modes as desired. (For details concerning mode switching, refer to "Switching the Operation Mode" on page 55.)

Precaution:

- If you do not replace dead batteries in the unit with new batteries, the unit's microcomputer returns to its initial settings. If this happens, all memorized adjusted DSP settings are erased. When you have completed DSP setting adjustment, be sure to record the settings on the supplied sheet.

PRO (Professional) mode

This lets you create of a 3-way multi-amp, multi-speaker system with separate speakers for reproduction of high, middle and low frequencies (bands), each driven by a dedicated power amp.

The PRO mode provides Network and Time Alignment functions, two functions essential for a multi-amp, multi-speaker system, to enable precise control over settings for each frequency range.

STD (Standard) mode

This lets you create a 4-speaker system with front and rear speakers, or a 6-speaker system with front and rear speakers and subwoofers.

The STD mode provides a Sound Field Control function offering an easy way to recreate realistic sound fields in your car.

Common Functions

Auto-equalizing (see page 68)

This function automatically measures the acoustic characteristics of the car interior, and performs acoustic compensation (equalization) based on that data.

Auto-equalizer (see page 72)

Enables switching between three Auto-equalizer curves created by the Auto-equalizing function.

Balance Adjustment (see page 78)

Enables adjustment of front and rear left/right speaker volume balance.

Note:

- In the PRO mode, only left/right speaker volume balance adjustment is possible.

Graphic Equalizer (see page 73)

Enables adjustment of equalization to match car interior acoustic characteristics as desired.

Position Selector (see page 58)

Enables adjustment of stereo sound image position to match seating location and the number of people in the car.

Network (see page 61)

Enables adjustment of reproduced frequency range, level, phase and other settings for each speaker unit.

Loudness (see page 79)

Compensates for insufficient bass and high-range during low-volume listening to provide a natural, well-defined sound.

Automatic Sound Levelizer (see page 79)

Automatically changes sound quality (equalization) to compensate for changing noise levels inside the car.

Source Level Adjustment (see page 80)

This function enables adjustment of the volume levels of other sources to match the standard FM volume level.

Special PRO (Professional) Mode Function

Time Alignment (see page 59)

Enables compensation for differences in the distance from the high, middle and low range speakers inside a car.

Special STD (Standard) Mode Function

Sound Field Control (see page 77)

Recreates the acoustic characteristics (sound fields) of a variety of performance venues in your car.

Using the Digital Signal Processor (DSP)

Switching the Operation Mode

- **Set the PRO/STD switch to PRO or STD.**

Set the PRO/STD switch on the side of the unit to the desired Operation mode with a pen tip or other pointed instrument. After switching, reset the unit. (Refer to "Resetting the Microprocessor" on page 6.)

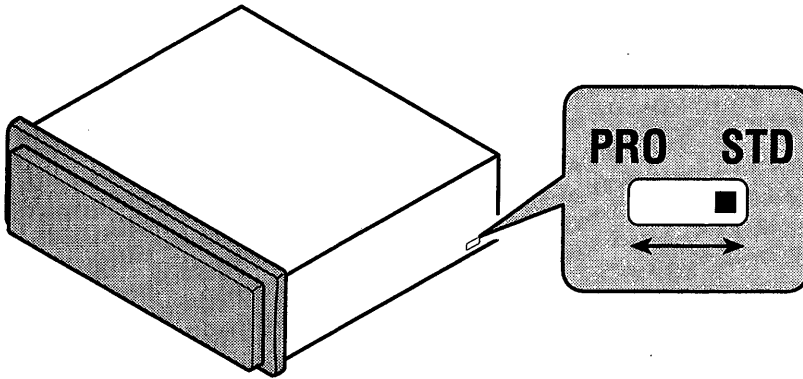

Note:

- If you press the RESET button, information in the unit's Preset memory and other information is erased.

Entering the DSP Function Menu

In this menu you can select DSP Functions.

- **Select the desired mode in the DSP Function Menu.**

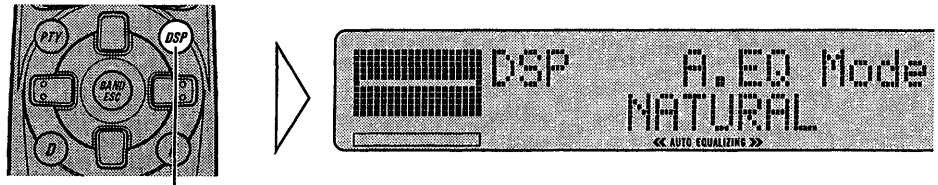

Each press
changes the Mode ...

■ PRO mode

Each press of the DSP button selects the mode in the following order:

Auto-equalizer mode (A.EQ Mode)* → Balance Adjustment mode (Balance) → Graphic Equalizer mode (EQ-Nuance) → 13-Band Graphic Equalizer Adjustment mode (EQ-Fine)** → Position Selector mode (Position)

* If Auto-equalizing is not performed, you cannot switch to the Auto-equalizer mode.

** You can switch to the 13-Band Graphic Equalizer Adjustment mode only when selecting a user curve in the Graphic Equalizer mode.

To cancel the DSP Function Menu, press the BAND button.

Note:

- After entering the DSP Function Menu, if you do not perform an operation within about 30 seconds, the DSP Function Menu is automatically canceled.

■ STD mode

Each press of the DSP button selects the mode in the following order:

Auto-equalizer mode (A.EQ Mode)* → Balance Adjustment mode (Fader) → Graphic Equalizer mode (EQ-Nuance) → 13-Band Graphic Equalizer Adjustment mode (EQ-Fine)** → Sound Field Control (SFC Mode) → Position Selector mode (Position)

* If Auto-equalizing is not performed, you cannot switch to the Auto-equalizer mode.

** You can switch to the 13-Band Graphic Equalizer Adjustment mode only when selecting a user curve in the Graphic Equalizer mode.

To cancel the DSP Function Menu, press the BAND button.

Note:

- After entering the DSP Function Menu, if you do not perform an operation within about 30 seconds, the DSP Function Menu is automatically canceled.

Using the Digital Signal Processor (DSP)

Entering the DSP Detailed Setting Menu

In this Menu, you can select functions enabling adjustment of settings to match conditions in your car, such as the Network mode and Automatic Sound Levelizer.

- Enter the DSP Detailed Setting Menu.

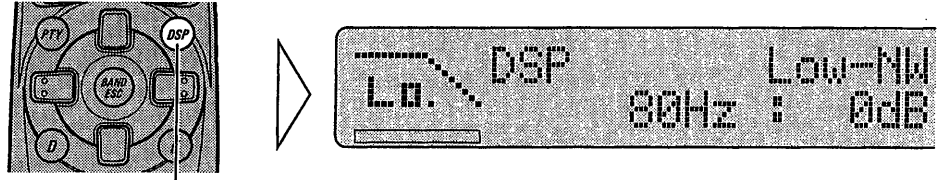

Hold for 2 seconds

■ PRO mode

Each press of the DSP button selects the mode in the following order:

Network mode (Low-NW) → Time Alignment mode (T.Alignment) →
Loudness mode (Loudness) → Automatic Sound Levelizer mode (ASL) →
Source Level Adjustment mode (SLA)*

* When the source is an FM broadcast, you cannot switch to the Source Level Adjustment mode (SLA).

To cancel the DSP Detailed Setting Menu, press the BAND button.

Note:

- After entering the DSP Detailed Setting Menu, if you do not perform an operation within about 30 seconds, the DSP Detailed Setting Menu is automatically canceled.

■ STD mode

Each press of the DSP button selects the mode in the following order:

Network mode (Sub-W-NW) → Loudness mode (Loudness) → Automatic
Sound Levelizer mode (ASL) → Source Level Adjustment mode (SLA)*

* When the source is an FM broadcast, you cannot switch to the Source Level Adjustment mode (SLA).

To cancel the DSP Detailed Setting Menu, press the BAND button.

Note:

- After entering the DSP Detailed Setting Menu, if you do not perform an operation within about 30 seconds, the DSP Detailed Setting Menu is automatically canceled.

Position Selector Function

One way to assure a more natural sound is to clearly position the stereo sound image (putting you in the center of the sound field).

The Position Selector function adjusts delay time and volume level of sound from each speaker to match seat positions and the number of people in the car, and lets you recall settings at the touch of a button. The result is a natural sound regardless of the seat you are sitting in.

Button	Position
▲	Front seat
▼	Front and Rear seat
◀	Driver's seat (steering located on the LEFT side)
▶	Driver's seat (steering located on the RIGHT side)

Note:

- In the PRO mode, front and rear seats cannot be selected.

About the Position Indicator

This lets you confirm current Position setting without switching to the Position Selector mode.

Front-Left



Front-Right



Front



All



Setting the Listening Position

1. Select the Position Selector mode (Position) in the DSP Function Menu.
2. Press one of buttons ▲/▼/◀/▶ to select the desired Position. (e.g. Press button ◀.)

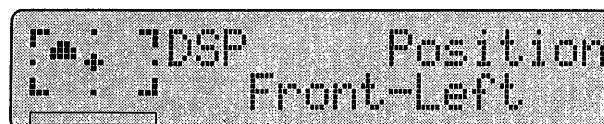
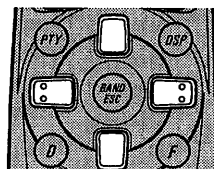
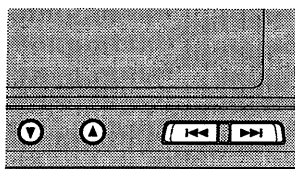

To cancel the listening position, press the same button again.

Note:

- In the PRO mode, pressing the ▼ button cancels the listening position.

Using the Digital Signal Processor (DSP)

Time Alignment Function (PRO mode)

Inside a car, because of the big difference between the distances from each of the speakers to your listening position, sound from each of the speakers reaches your ears at different times. With a multi-amp, multi-speaker system, because this results in different frequencies (high, middle, low) reaching your ears at different times, stereo imaging and balance and frequency response are degraded.

The Time Alignment function delays the music signal from near speaker units to assure that sound from each speaker reaches your ears at the same time. To compensate for this difference with this unit, set the distances of each of the speaker units from the driver's seat. Delay time is then automatically set for you. Although the distance from each speaker depends on which seat you are sitting in, if you perform settings once for the driver's seat, you can easily switch listening positions with the Position Selector Function (refer to page 58) to automatically provide optimum delay settings for any seating arrangement.

Setting the Time Alignment

1. Select the Time Alignment mode (T.Alignment) in the DSP Detailed Setting Menu.
2. Select the driver's seat Position.

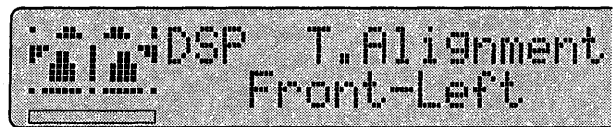
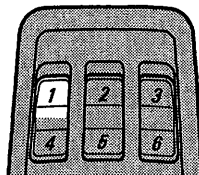

Each press of button 1 switches the driver's position left or right.

Note:

- If the driver's seat position is not set, distance adjustment in step 5 cannot be performed.

3. Select the unit of distance (centimeter (cm) or inch).

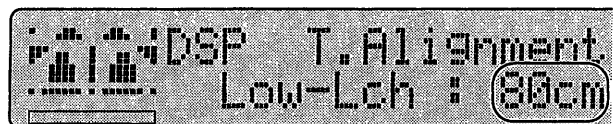

Each press of button 2 switches the unit of distance to centimeters (cm) or inches.

4. Select a speaker unit in the following order:

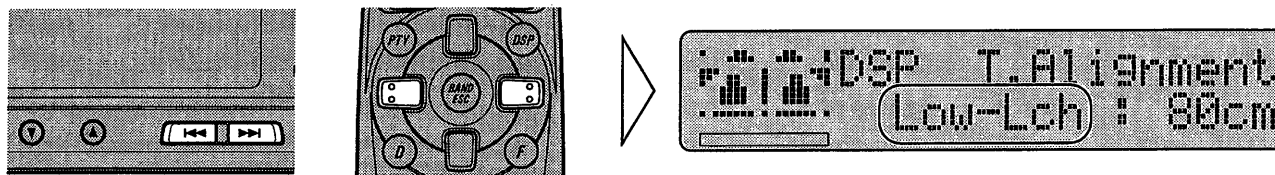

Low-Lch ↔ Low-Rch ↔ Mid-Lch ↔ Mid-Rch ↔ High-Lch ↔ High-Rch

Display	Speaker Type
High-Rch	Right high-range speaker
High-Lch	Left high-range speaker
Mid-Rch	Right middle/bass speaker
Mid-Lch	Left middle/bass speaker
Low-Rch	Right subwoofer
Low-Lch	Left subwoofer

5. Adjust the distance between the selected speaker unit and the driver's head position.

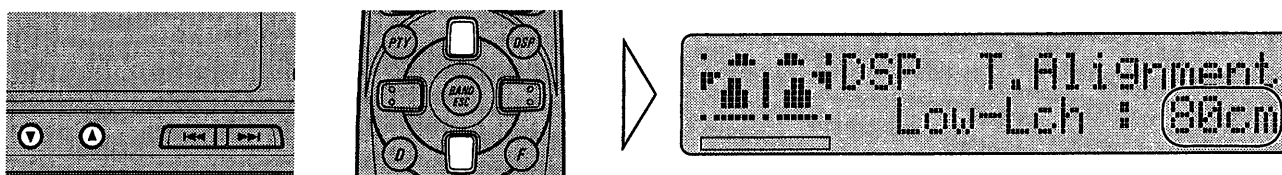

If you select centimeters (cm) in step 3, "0 cm" – "400 cm" is indicated in the display.

If you select inches in step 3, "0.0" – "160.0" is indicated in the display.

6. Repeat steps 4–5 above for the other speaker unit adjustment.

Note:

- When there is only one subwoofer connected, set the same distance for "Low-Rch" and "Low-Lch".

Network Function

This unit's Network function lets you divide the audio signal into different frequency bands, and then reproduce each of them through separate speaker units.

You can then make precise adjustments to the reproduced frequency band (with a low-pass filter or high-pass filter), level, phase and other parameters to match the characteristics of each speaker unit.

Adjustable Parameters

The Network function enables adjustment of the following parameters. Make adjustments in line with the reproduced frequency band and characteristics of each connected speaker unit.

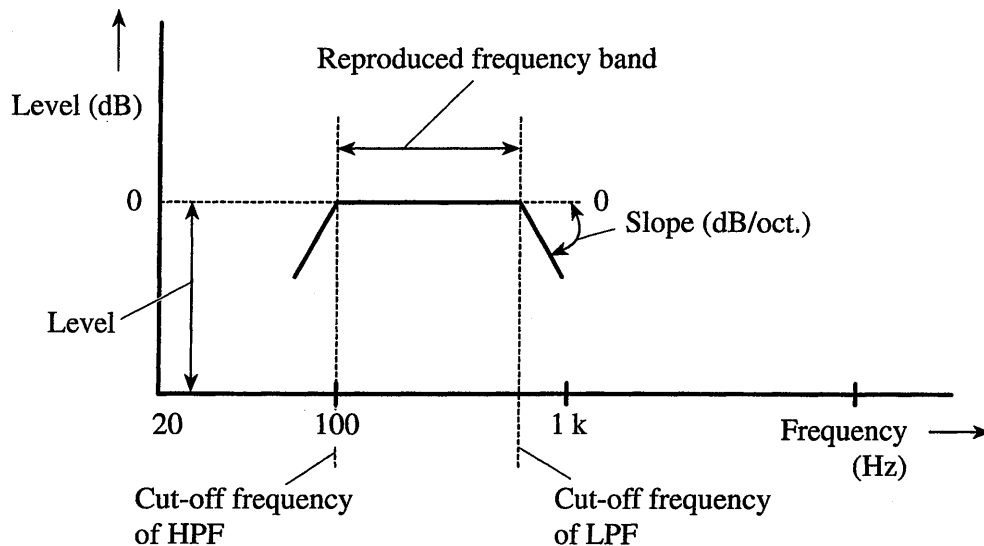

■ Reproduced Frequency Band

Adjusting the high-pass filter (H.P.F.) or low-pass filter (L.P.F.) cut-off frequency lets you set the reproduced frequency band for each speaker unit.

- The H.P.F. cuts frequencies (low) below the set frequency, letting high frequencies through.
- The L.P.F. cuts frequencies (high) above the set frequency, letting low frequencies through.

■ Level

The difference in reproduced levels between speaker units can be corrected.

■ Slope

Adjusting H.P.F./L.P.F. slope (filter attenuation slope) lets you adjust the continuity of sound between speaker units.

- The slope indicates the number of decibels (dB) the signal is attenuated when the frequency is one octave higher (lower) (Unit: dB/oct.). The steeper the slope, the more the signal is attenuated.

■ Phase

You can switch phase (Normal, Reverse) for each speaker unit's input signal (Subwoofer only in the STD mode). When the continuity of sound between speakers is imprecise, try switching phase. This may improve the continuity of sound between speakers.

■ Subwoofer Monaural/Stereo Switching (PRO mode)

You can select the desired type of Subwoofer (Low-NW) output (monaural or stereo).

Points Concerning Network Adjustments

■ Cut-off frequency adjustment (PRO mode)

- With the subwoofer installed in the rear tray, if you set the "Low-NW" cut-off frequency high, bass sound is separated so that it appears to come from the rear. You are recommended to set the "Low-NW" cut-off frequency to 100 Hz or lower.
- The maximum input power setting for middle/bass and high-range speakers is usually lower than that for subwoofers. Remember that if the "Mid_HPF-NW" or "High-NW" cut-off frequency is set lower than required, strong bass signal input may damage the speaker.

■ Cut-off frequency adjustment (STD mode)

- With the subwoofer installed in the rear tray, if you set the "Sub-W-NW" cut-off frequency high, bass sound is separated so that it appears to come from the rear. You are recommended to set the "Sub-W-NW" cut-off frequency to 100 Hz or lower.

■ Level adjustment (PRO mode)

- The basic frequencies of many musical instruments are in the middle range. First perform middle/bass level adjustment, followed by high-range and then subwoofer level adjustment in that order.

Using the Digital Signal Processor (DSP)

■ Slope adjustment

- If you set a small absolute value for the slope (for a gentle slope), interference between adjacent speaker units can easily result in degraded frequency response.
- If you set a large absolute value for the slope (for a steep slope), continuity of sound between speaker units is degraded, and sounds appear to be separated.
- If you set the slope to 0 dB/oct., the audio signal bypasses the filter, so the filter does not have an effect.

■ Phase adjustment

- When the cross-over point value for filters on both sides is set to -12 dB/oct., phase is reversed 180 degrees at the filter cut-off frequency. In this case, reversing phase assures improved sound continuity.

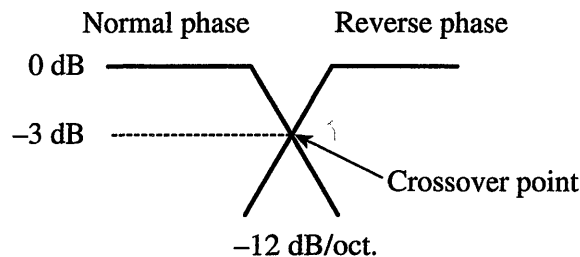

Network Adjustment

Before performing network adjustment, you are recommended to adjust Time Alignment.

1. Select the Network mode (Low-NW or Sub-W-NW) in the DSP Detailed Setting Menu.

- “Low-NW” in the PRO mode, “Sub-W-NW” in the STD mode.

2. Press one of buttons 3–6 to select the speaker unit (filter) to be adjusted. (e.g. Press button 4.)

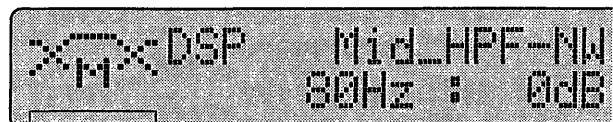
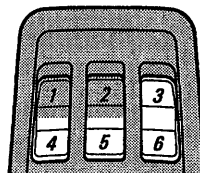

Note:

- In the STD mode, button 3 does not function.

PRO mode

Button	Display	Filter Type
3	Low-NW	Subwoofer LPF
4	Mid_HPF-NW	Middle/bass speaker HPF
5	Mid_LPF-NW	Middle/bass speaker LPF
6	High-NW	High-range speaker HPF

Note:

- In the PRO mode when setting the Subwoofer (Low-NW), you can switch between Monaural/Stereo subwoofer output. (Refer to “Subwoofer Monaural/Stereo Switching” on page 67.)

STD mode

Button	Display	Filter Type
4	Sub-W-NW	Subwoofer LPF
5	Front-NW	Front speaker HPF
6	Rear-NW	Rear speaker HPF

3. Press one of buttons 3–6 for 2 seconds or more to mute other speaker units other than the speaker unit using the filter to be adjusted. (e.g. Press the button other than button 4.)

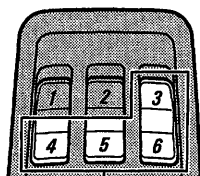

Hold for 2 seconds

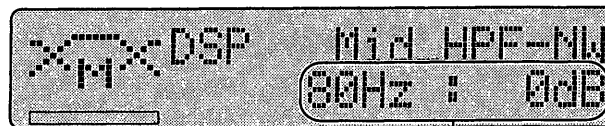

* “Mute : On”

- * If you mute the selected speaker unit (filter), “Mute : On” is indicated and adjustment is not possible.

To cancel muting, press the same button again for 2 seconds or more.

You can mute each speaker unit (filter). When a speaker unit is muted, no sound is output from that speaker. Perform network adjustment while switching mute ON/OFF as required.

Note:

- In the STD mode, button 3 does not function.

Using the Digital Signal Processor (DSP)

4. Adjust the cut-off frequency (crossover frequency) of the selected speaker unit (filter).

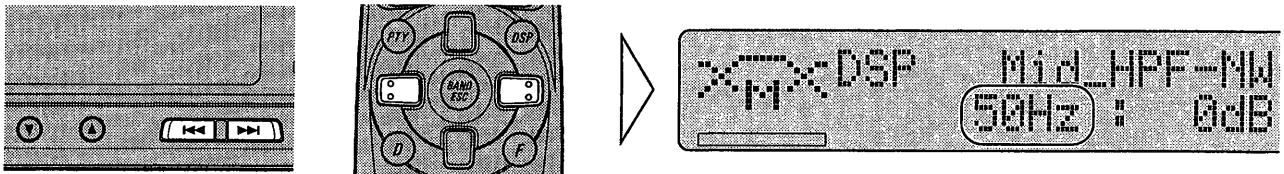

PRO mode

Display	Cut-off frequency
Low-NW	40, 50, 63, 80, 100, 125, 160, 200, 250 Hz
Mid_HPFF-NW	40, 50, 63, 80, 100, 125, 160, 200, 250 Hz
Mid_LPF-NW	2, 2.5, 3.15, 4, 5, 6.3, 8, 10, 12.5 kHz
High-NW	2, 2.5, 3.15, 4, 5, 6.3, 8, 10, 12.5 kHz

STD mode

Display	Cut-off frequency
Sub-W-NW	50, 63, 80, 100, 125, 160, 200 Hz
Front-NW	50, 80, 125, 200 Hz
Rear-NW	50, 80, 125, 200 Hz

5. Repeat steps 2–4 above for the other speaker units (filters).
6. Adjust the level of the selected speaker unit (filter).

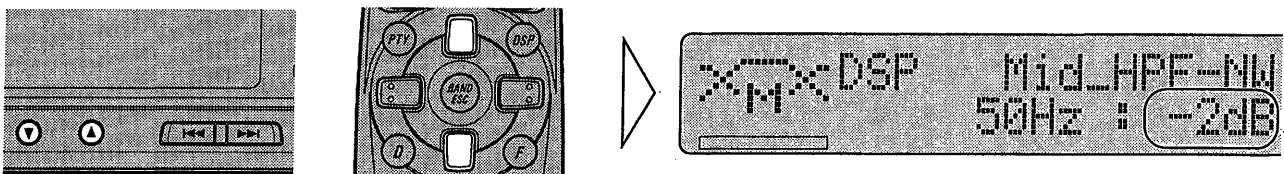

PRO mode

Display	Level
Low-NW	-24 — +6
Mid_HPFF-NW	-24 — 0
Mid_LPF-NW	-24 — 0
High-NW	-24 — +6

STD mode

Display	Level
Sub-W-NW	-24 — +6
Front-NW	-24 — 0
Rear-NW	-24 — 0

7. Repeat steps 2, 3 and 6 above for the other speaker units (filters).

Adjust level of each speaker unit (filter) to achieve a good overall balance.

8. Adjust the slope of the selected speaker unit (filter).

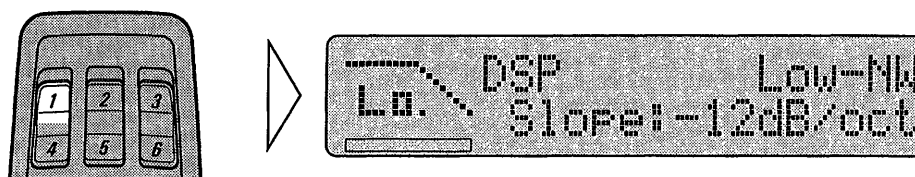

Each press of button 1 selects the slope.

PRO mode

Display	Slope
Low-NW	-12, -18, -24, -30, -36 dB/oct.
Mid_HP-F-NW	0, -6, -12, -18, -24 dB/oct.
Mid_LPF-NW	0, -6, -12, -18, -24 dB/oct.
High-NW	-6, -12, -18, -24 dB/oct.

STD mode

Display	Slope
Sub-W-NW	-6, -12, -18 dB/oct.
Front-NW	0, -6, -12 dB/oct.
Rear-NW	0, -6, -12 dB/oct.

9. Repeat steps 2, 3 and 8 above for the other speaker units (filters) adjustments.

Take into consideration continuity of sound between adjacent speakers, and adjust the slope for each filter.

Using the Digital Signal Processor (DSP)

10. Adjust the phase of the selected speaker unit (filter).

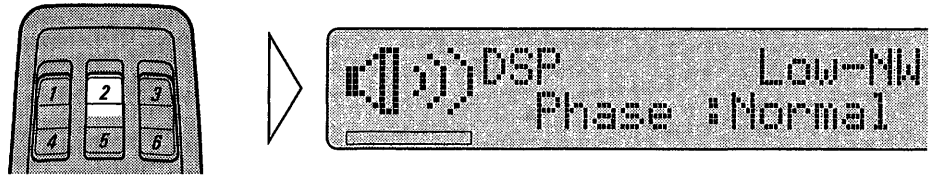

Each press of button 2 switches the phase to normal or reverse.

Note:

- In the STD mode, you cannot switch front speaker "Front-NW" or rear speaker "Rear-NW" phase. Switch subwoofer "Sub-W-NW" phase.

11. Repeat steps 2, 3 and 10 above for the other speaker units (filters).

Adjust phase of each speaker unit (filter) to achieve good sound continuity between adjacent speakers units.

Subwoofer Monaural/Stereo Switching (PRO mode)

This unit features stereo subwoofer outputs (left/right channels). When using a single subwoofer due to limited installation space, or when you want monaural output from two subwoofers, you can switch subwoofer output to Monaural.

1. Select the Subwoofer Setting mode (Low-NW) in the Network mode.
2. Switch the Subwoofer Output mode.

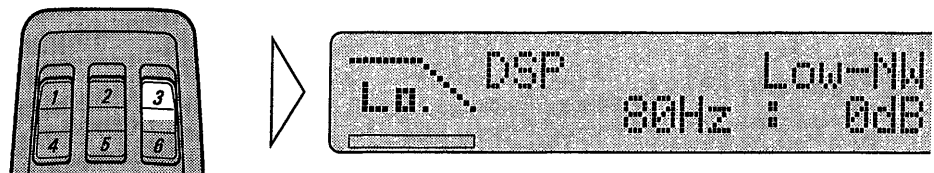

3. Switch the Subwoofer output.

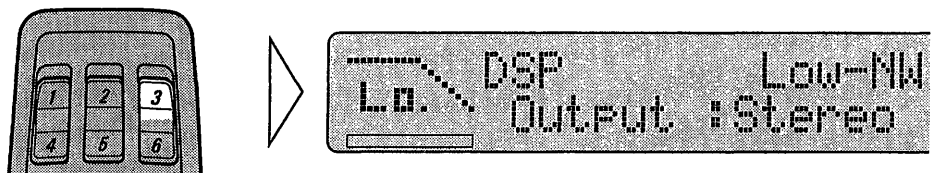

Each press of button 3 switches the subwoofer output to monaural or stereo.

Auto-equalizing Function

This unit's Auto-equalizer automatically measures car interior acoustic characteristics, and then creates three Auto-equalizer curves based on that information.

Before Operating the Auto-equalization

■ WARNING:

- To prevent accidents, never perform Auto-equalizing when driving. When this function measures car interior acoustic characteristics to create an Auto-equalizer curve, a loud measurement tone (noise) may be output from the speakers.

■ Precaution:

- Performing Auto-equalizing under the following conditions may damage the speakers. Be sure to check conditions thoroughly before performing Auto-equalizing.
 - * When speakers are incorrectly connected. (e.g. When a high-range speaker is connected to a mid/bass or subwoofer output.)
 - * When a speaker is connected to a power amp delivering output higher than the speaker's maximum input power capability.
 - * When the Network function (refer to page 61) reproduced frequency setting extends beyond the range of high-range and other speakers with limited reproduced frequency settings.
- If the microphone is placed in an unsuitable position the measurement tone may become loud and measurement may take a long time, resulting in a drain on battery power. Be sure to place the microphone in the specified location. (Refer to page 70.)

■ Read this before performing Auto-equalizing

- Perform Auto-equalizing in as quiet a place as possible, with the car engine and air conditioning switched off. Also cut power to car or portable telephones in the car, or remove from the car before performing Auto-equalizing. Sounds other than the measurement tone (surrounding sounds, engine sound, telephones ringing etc.) may prevent correct measurement of car interior acoustic characteristics.
- Be sure to perform Auto-equalizing with the supplied microphone. Using another microphone will prevent measurement, or result in incorrect measurement of car interior acoustic characteristics.
- With no middle/bass speaker connected in the PRO mode, or no front or rear speaker connected when in the STD mode, Auto-equalizing cannot be performed.

Using the Digital Signal Processor (DSP)

- When connected to a power amp with input level control, Auto-equalizing may not be possible if you lower power amp input level. Set the power amp's input level to the standard position.
- After normal completion of Auto-equalizing, fader/balance settings (refer to page 78) return to the center position (initial settings).
- Auto-equalizing results may differ depending on the Network mode cut-off frequency, slope and mute settings (refer to page 61). (In the PRO mode, subwoofer Mono/Stereo and Time Alignment setting also have an effect on equalizing results.) Before performing Auto-equalizing, adjust settings for these parameters. (If Auto-equalizing results are not satisfactory, change these settings and perform Auto-equalizing again. This may enable you to achieve favorable results.) Also, during Auto-equalizing, mute for a speaker is not canceled, so if you want to use the Auto-equalizer curve for that speaker, cancel mute beforehand.
- Three types of Auto-equalizer curves are created. If you perform Auto-equalizing when Auto-equalizer curves already exist, the previous curves are erased.
- When you perform Auto-equalizing, adjustments are automatically made to the following Network function parameters (refer to page 61), changing any settings you may have made.
 - * Volume level of each speaker unit.
 - * Phase of each speaker unit. (In the STD mode, only the subwoofer.)
 - * STD mode rear speaker H.P.F. "Rear-NW" cut-off frequency and slope. (Only when a subwoofer is connected.)
- If you perform Auto-equalizing, the equalizer curve switches to flat.
- After the Auto-equalizing function countdown has started, if you switch a source ON by loading a CD or with the voice controller, source DSP settings change. Do not switch a source ON after Auto-equalizing has begun.

Auto-equalizing

1. Select the position for the seat on which the microphone is placed.

(Refer to "Position Selector Function" on page 58.)

- When not setting for the "Driver's seat (steering wheel on the left)" or "Driver's seat (steering wheel on the right)", if you start Auto-equalizing, "Driver's seat (steering wheel on the left)" is automatically selected.

2. In the PRO mode, adjust Time Alignment.

(Refer to page 59.)

3. Perform Network adjustment.

(Refer to page 61.)

4. Stop the car in a place that's as quiet as possible, close all doors, windows, the sun roof, and switch the engine off.

If the engine is left running, engine noise may prevent correct Auto-equalizing.

5. Fix the provided microphone in the center of the headrest of the driver's seat, facing forward, using the belt (sold separately).

The Auto-equalizer curve may differ depending on where you place the microphone. If desired, place the microphone on the front passenger seat and perform Auto-equalizing.

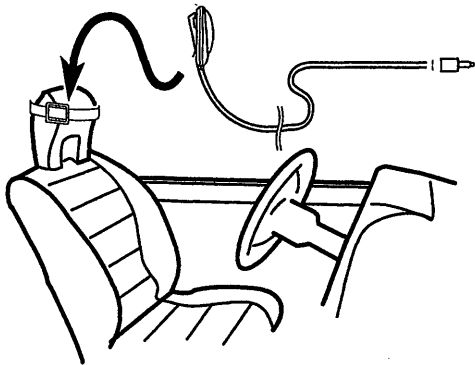

6. Switch the ignition switch to ON or ACC.

If the car's air conditioner or heater is switched on, switch it off. Noise from the fan in the air conditioner or heater may prevent correct Auto-equalizing.

7. Switch the source OFF.

(Refer to "Switching Power ON/OFF" on page 11.)

8. Enter the Auto-equalizing mode with the source OFF.

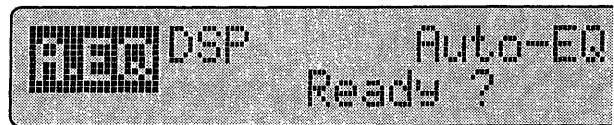
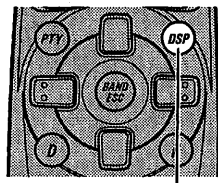

Hold for 2 seconds

The front panel opens automatically.

Using the Digital Signal Processor (DSP)

9. Plug the provided microphone into the microphone input jack on this unit.

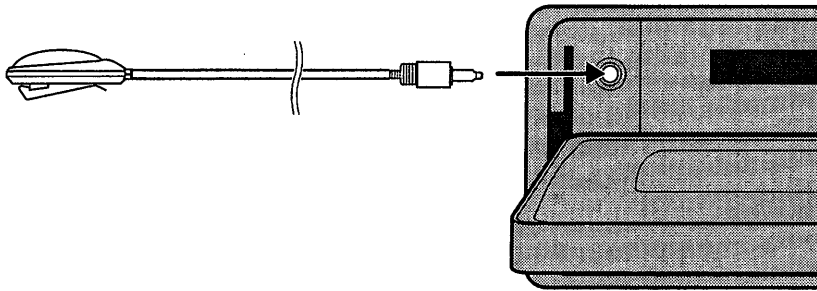

10. Start the Auto-equalizing.

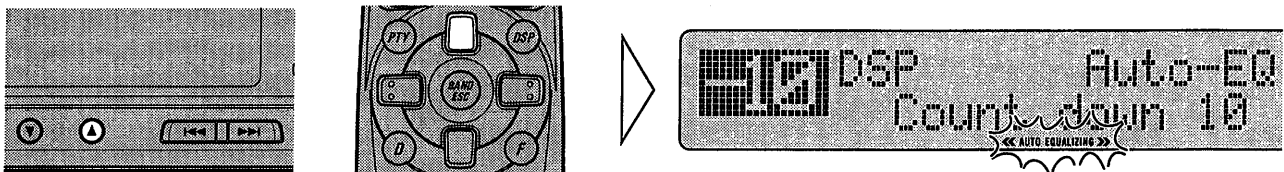

11. Get out of the car and close the door within 10 seconds, if a 10-second count-down starts.

The measurement tone (noise) is output from the speakers, and Auto-equalizing (acoustic characteristics measurement and compensation) begins.

Note:

- When all speaker units are connected, Auto-equalizing is completed in about 7 or 8 minutes.
- To cancel Auto-equalizing part way through, press any button.

12. When Auto-equalizing is completed, a message is displayed as below.

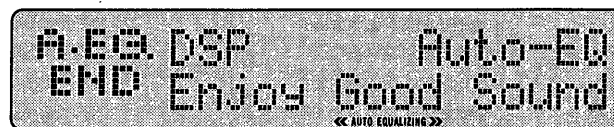

When correct measurement of car interior acoustic characteristics is not possible, an error message is displayed. (Refer to error messages on the next page.)

13. To cancel the Auto-equalizing mode, press a button.

14. Store the microphone carefully in the glove compartment.

Store the microphone carefully in the glove compartment or other safe place. If the microphone is subjected to direct sunlight for an extended period, high temperatures may cause it to deform, change color and malfunction.

Error Cords of Auto-equalizing Function

When correct measurement of car interior acoustic characteristics is not possible with the Auto-equalizer, the following error messages are displayed. After checking, try again.

Display	Cause	Remedy
MIC ERROR	Microphone is not connected.	Plug in the supplied microphone securely into the jack.
SPEAKER ERROR	The microphone cannot pick up the measuring tone of the middle/bass speaker unit in PRO mode or the front and rear speakers in STD mode.	Confirm that the speakers are connected correctly.
		Set the input level setting of the power amp connected to the speakers correctly.
		Correctly set the microphone.
		Confirm that the Network mode mute is OFF.
NOISE ERROR	The surrounding noise level is too high.	Stop your car in a place that's as quite as possible, and switch off the engine and air conditioner or heater.
		Correctly set the microphone.

Auto-equalizer Function

The Auto-equalizer creates three types of Auto-equalizer curves to compensate for car interior acoustic characteristics.

You can switch between these Auto-equalizer curves as desired.

About Auto-equalizer Curves

Display	Equalizer Curve	Contents
NATURAL	Natural	Compensation providing nearly flat equalization for a smooth, natural sound.
MILD	Mild	Optimum compensation for listening to quiet music.
DYNAMIC	Dynamic	Optimum compensation for jazz, rock and other music.

Using the Digital Signal Processor (DSP)

Selecting the Auto-equalizer Curve

You can switch between Auto-equalizer curves.

Note:

- In this mode, you cannot switch if you do not perform Auto-equalizing.

1. **Select the Auto-equalizer mode (A.EQ Mode) in the DSP Function Menu.**
2. **Select the desired Auto-equalizer curve in the following order:**

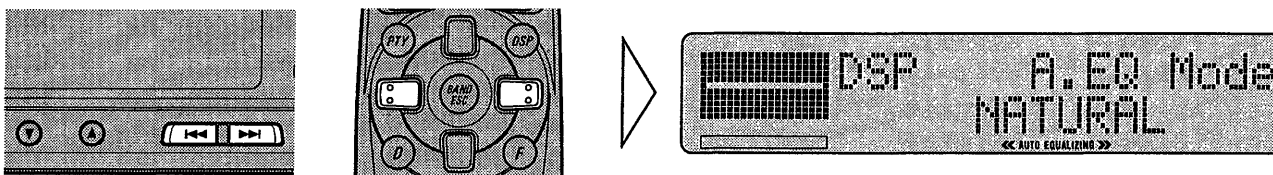

NATURAL ↔ MILD ↔ AUTO-EQ OFF (Auto-equalizer curve off) ↔ DYNAMIC

Graphic Equalizer Function

Compared to compensation for car interior acoustic characteristics provided by the Auto-equalizing function, this lets you create your own equalization curves as desired.

There are two types of equalizer curves: Default equalizer curves (Factory curves) and user-defined equalizer curves (User curves).

It is possible to select a different equalizer curve for each source. (The built-in CD player and multi-CD player are set to the same equalizer curve automatically.)

Note:

- Four factory curves are provided: Rock, Pop, Vocal and Flat.

About the Flat and User Curves

■ Flat

No supplement or correction is made to the sound. A useful function to check the effect of the equalizer curves by switching alternatively between FLAT and a set equalizer curve.

■ User Curves (Custom 1, 2)

User curves (Custom 1, 2) can be stored as adjusted equalizer curves. Adjustment can be made by either using Nuance Control Equalizer (N.C.E.) or 13-Band Graphic Equalizer Adjustment.

Button	Display	Equalizer Curve
1	Rock	Rock
2	Pop	Pops
3	Vocal	Vocal
4	Flat	Flat
5, 6	Custom 1, 2	User 1, 2

Recalling the Equalizer Curve

You can easily recall equalizer curves. There are two ways to do it.

■ Direct Recall

1. Select the Graphic Equalizer mode (EQ-Nuance) in the DSP Function Menu.
2. Select the desired equalizer curve. (e.g. Press button 1.)



■ Sequential Recall

1. Select the Graphic Equalizer mode (EQ-Nuance) in the DSP Function Menu.
2. Select the desired equalizer curve in the following order:

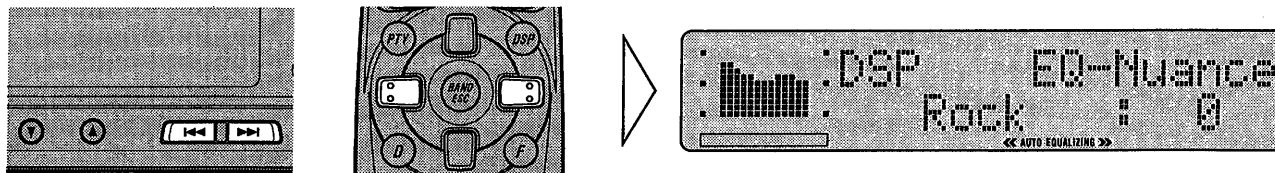

Rock ↔ Pop ↔ Vocal ↔ Flat ↔ Custom 1 ↔ Custom 2

Using the Digital Signal Processor (DSP)

Adjusting the Equalizer Curves

The 4 factory curves can be adjusted (fine adjustment).
Adjustment can be made by either using Nuance Control Equalizer (N.C.E.) or 13-Band Graphic Equalizer Adjustment.

■ Nuance Control Equalizer (N.C.E.)

The factory curves can be adjusted at fine levels (nuance control).

1. Select the Graphic Equalizer mode (EQ-Nuance) in the DSP Function Menu.
2. Recall the equalizer curve you want to adjust. (See previous page.)
3. Adjust the equalizer curve.

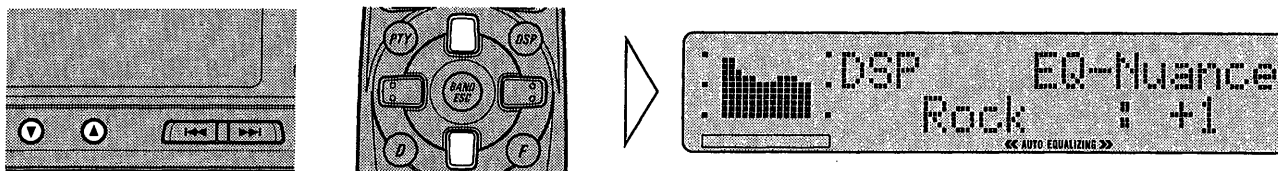

Display shows "+6" – "-6".

■ 13-Band Graphic Equalizer Adjustment

You can select this mode only when you select the user curve (Custom 1 or 2).

1. Select the Graphic Equalizer mode (EQ-Nuance) in the DSP Function Menu.
2. Recall the user curve (Custom 1 or 2). (See previous page.)
3. Select the 13-Band Graphic Equalizer Adjustment mode (EQ-Fine) in the DSP Function Menu.

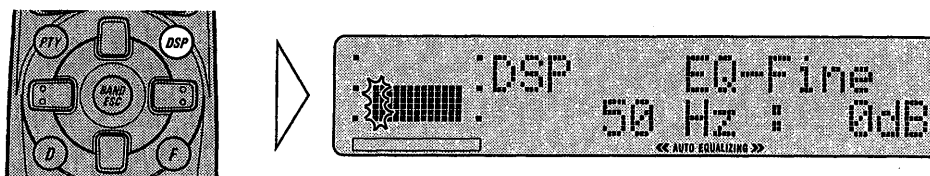

Note:

- Storing Nuance Control Equalizer (N.C.E.) settings as a user curve enables fine adjustment of the curve after Nuance Control. (Refer to "Storing the Equalizer Curves" on the next page.)

4. Select the band to be adjusted.

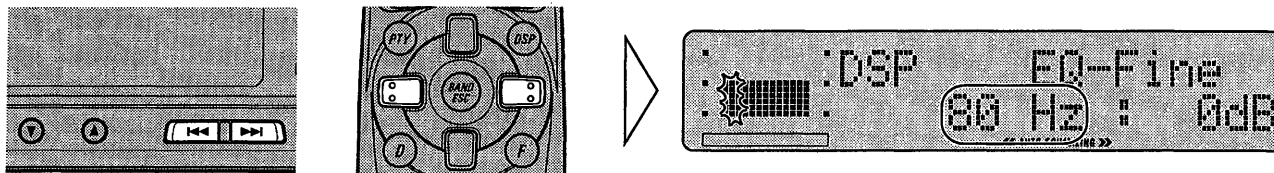

5. Adjust the level.

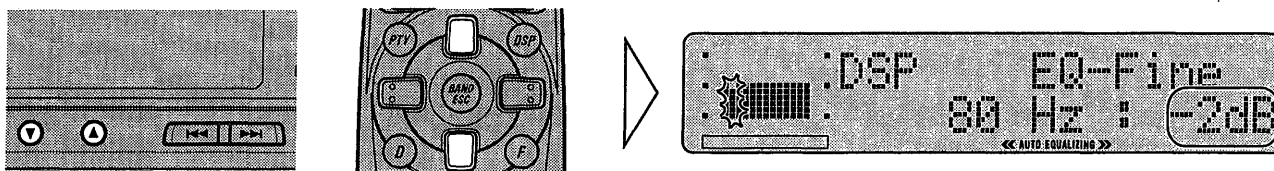

6. Repeat steps 4–5 above for the other band adjustments.

Storing the Equalizer Curves

The adjusted equalizer curves can be stored in user curves (Custom 1 or 2).

1. Adjust the equalizer curve.

(See the section “Adjusting the Equalizer Curves” on previous page.)

2. Press button 5 or 6 for 2 seconds or more to store the equalizer curve. (e.g. Press button 5.)

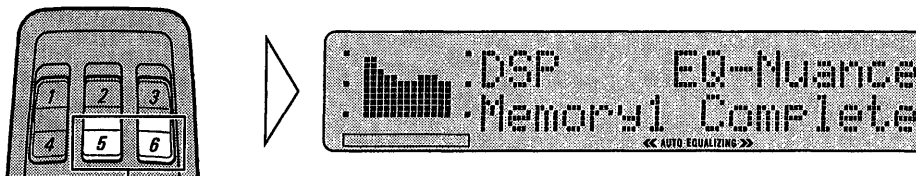

Hold for 2 seconds

Note:

- When adjusting a user curve (Custom 1 or 2), there's no need to store settings. Equalizer curves are automatically stored after adjustment. If you want to keep a curve already stored as a user curve, store in another user curve before adjusting.

Using the Digital Signal Processor (DSP)

Sound Field Control Function (STD mode)

The sound field control function (SFC) incorporates 6 programs for reproducing typical sound fields of a concert hall, stadium, etc. This function makes it possible to reproduce a realistic sound field of a concert hall, etc., in your car.

Recalling the Sound Field Program

There are two ways to recall a sound field program.

Button	Display	Sound Field Program
1	STUDIO	Studio
2	JAZZ	Jazzclub
3	CLUB	Club
4	CONCERT	Concert Hall
5	DOME	Dome
6	STADIUM	Stadium

■ Direct Recall

1. Select the SFC mode (SFC Mode) in the DSP Function Menu.
2. Select the desired sound field program. (e.g. Press button 1.)

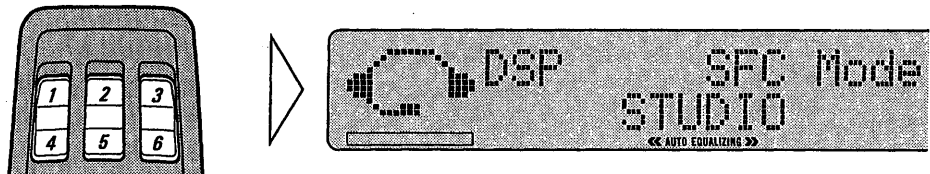

To cancel the sound field program, press the same button again.

■ Sequential Recall

1. Select the SFC mode (SFC Mode) in the DSP Function Menu.
2. Select the desired sound field program in the following order:

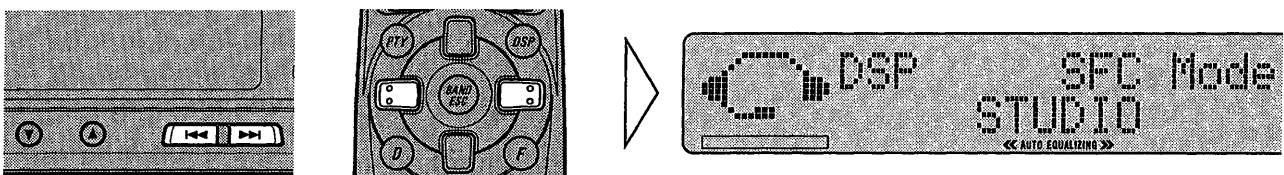

SFC OFF ↔ STUDIO ↔ JAZZ ↔ CLUB ↔ CONCERT ↔
DOME ↔ STADIUM

Balance Adjustment Function

This function allows you to select a Balance setting that provides ideal listening conditions in all occupied seats.

It is possible to select a different balance setting for each position.

■ PRO mode

1. Select the Balance Adjustment mode (Balance) in the DSP Function Menu.
2. Shift the balance to the left or right speaker, respectively.

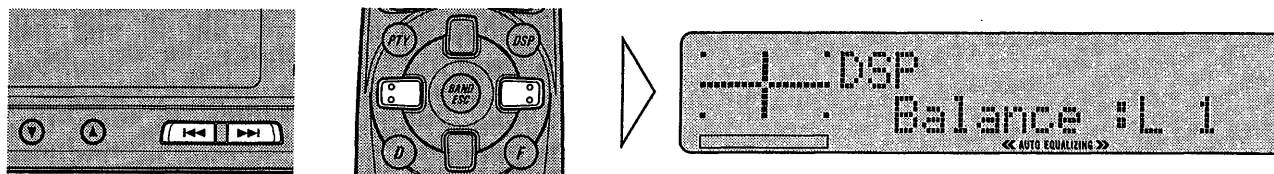

“L25” – “R25” is displayed as it moves from left to right.

■ STD mode

1. Select the Balance Adjustment mode (Fader) in the DSP Function Menu.
2. Shift the balance progressively to the front or rear speakers.

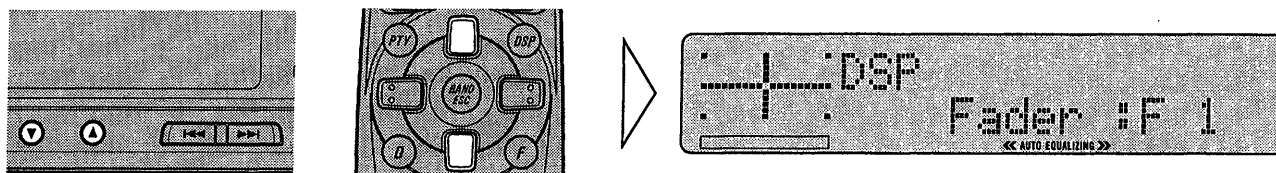

“F25” – “R25” is displayed as it moves from front to rear.

Note:

- “FAD : 0” is the proper setting when 2 speakers are in use.

3. Shift the balance to the left or right speaker, respectively.

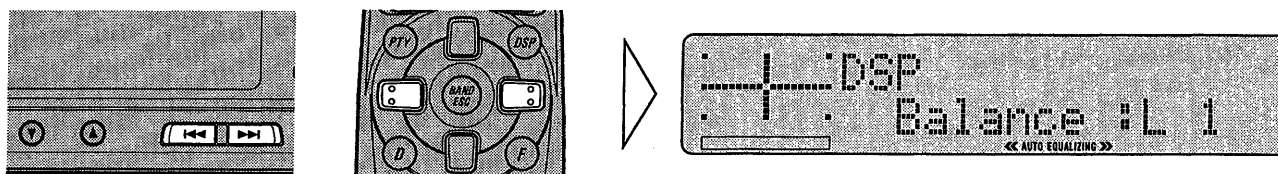

“L25” – “R25” is displayed as it moves from left to right.

Using the Digital Signal Processor (DSP)

Loudness Function

The Loudness function compensates for deficiencies in the low and high frequency ranges at low volume.

1. Select the Loudness mode (Loudness) in the DSP Detailed Setting Menu.
2. Switch the Loudness function ON or OFF.

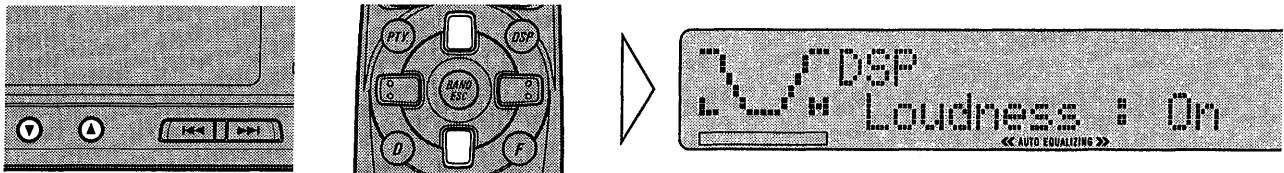

Automatic Sound Levelizer (ASL) Function

During driving, noise in the car changes according to the driving speed and road conditions. The automatic sound levelizer (ASL) monitors such varying noise and automatically increases the volume level, if this noise becomes greater. The sensitivity (variation of volume level to noise level) of ASL can be set to one of five levels.

1. Select the Auto Sound Levelizer mode (ASL) in the DSP Detailed Setting Menu.
2. Switch the Auto Sound Levelizer ON or OFF.

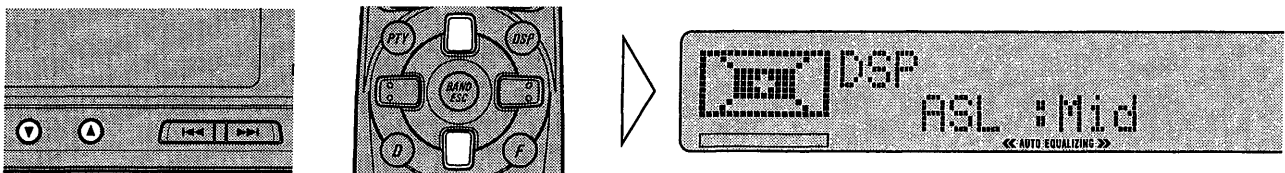

3. Select the desired level in the following order:

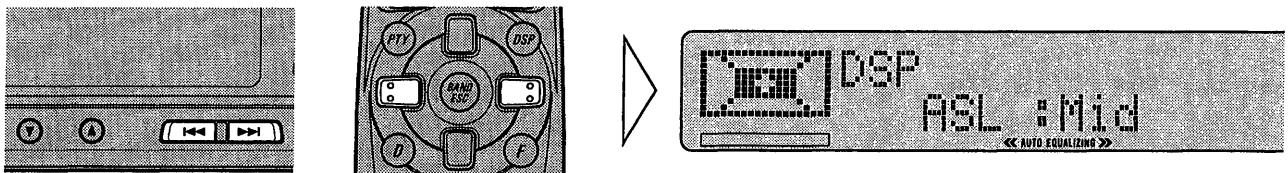

Low ↔ Mid-Low ↔ Mid ↔ Mid-High ↔ High

Source Level Adjustment (SLA) Function

The SLA function prevents radical leaps in volume level when switching between sources. Settings are based on the FM volume level, which remains unchanged. (Since the FM volume level is the control, SLA is not possible in the FM modes.)

The MW/LW, CD and AUX levels can all be adjusted. (The built-in CD player and multi-CD player are set to the same tone adjustment setting automatically.)

1. Compare the FM volume with the volume of the other source. (e.g. Built-in CD player.)
2. Select the Source Level Adjustment mode (SLA) in the DSP Detailed Setting Menu.
3. Increase or decrease the level.

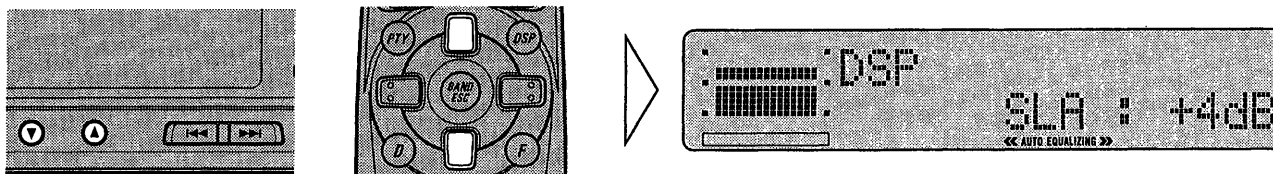

The display shows “+8” – “-8”.

Initial Setting

Entering the Initial Setting Menu

With this menu, you can perform initial settings for the product.

1. Switch the sources OFF.
2. Enter the Initial Setting Menu with the sources off.

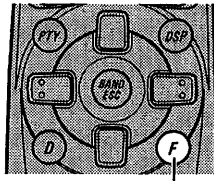

Hold for 2 seconds

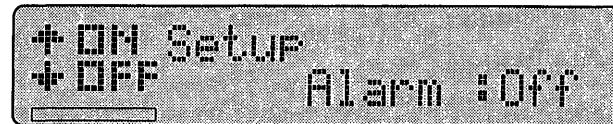

3. Select the desired mode.

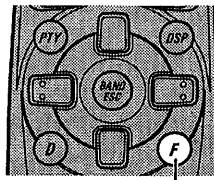

Each press
changes the Mode ...

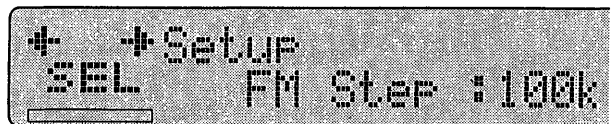
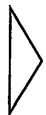

Each press of the FUNCTION button selects the mode in the following order:

Alarm → FM Step → DABpriority* → Auto-PI → WARNING → AUX
→ Dimmer → ILM.Color → Sense → DISP Filler

* You can only switch to the "DABpriority" mode when a separately sold "GEX-P900DAB" Hide-away DAB tuner is connected.

To cancel the Initial Setting Menu, press the BAND button.

Note:

- Alarm is a new feature of the "Removable Front Panel Alert". Refer to "RFP Alert Function" for details and instructions on how to use this function.
- Holding down the FUNCTION button for 2 seconds also cancels the Initial Setting Menu.

Changing the FM Tuning Step

Normally set at 50 kHz during Seek tuning in the FM mode, the tuning step changes to 100 kHz when the AF or TA mode is activated.

It may be preferable to set the tuning step to 50 kHz in the AF mode.

1. Select the FM tuning step mode (FM Step) in the Initial Setting Menu.
2. Select the desired tuning step.

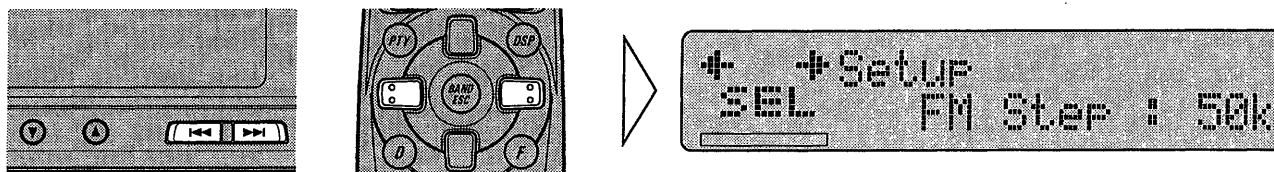

To cancel the Initial Setting Menu, press the BAND button.

Note:

- The tuning step remains set at 50 kHz during Manual tuning.
- The tuning step returns to 100 kHz if the battery is temporarily disconnected.

Setting the DAB Priority Function

When a "GEX-P900DAB" Hide-away DAB tuner is connected, this unit's RDS Traffic Announcement (TA) function lets you enjoy priority interruption of traffic information from the Hide-away DAB tuner.

■ When it is ON

During DAB reception, when the selected Service Component supports Road Traffic Flashes and Transport Flashes, reception is not interrupted by this unit's RDS Traffic Announcement (TA).

■ When it is OFF

Interruption is by the first received news flash from among this unit's RDS and the hide-away DAB traffic information broadcasts.

1. Select the DAB Priority Setting mode (DABpriority) in the Initial Setting Menu.
2. Switch the DAB Priority Setting ON or OFF.

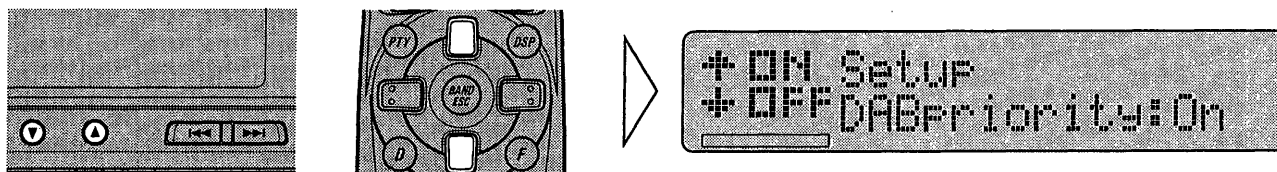

To cancel the Initial Setting Menu, press the BAND button.

Switching the Auto PI Seek Function

During Preset Station PI Seek operation, you can switch the Auto PI Seek function ON/OFF. (Refer to "PI Seek Function" on page 19.)

1. Select the Auto PI Seek mode (Auto-PI) in the Initial Setting Menu.
2. Switch the Auto PI Seek ON or OFF.

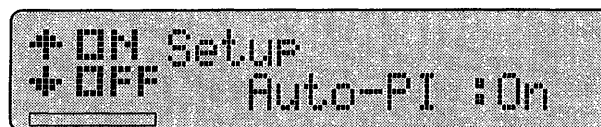
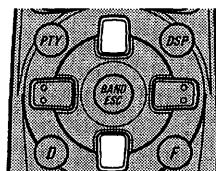
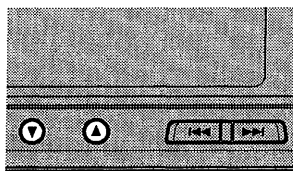

To cancel the Initial Setting Menu, press the BAND button.

Setting the Warning Tone

You can switch the Warning Tone function ON/OFF. (Refer to "Warning Tone" on page 10.)

1. Select the Warning Tone mode (WARNING) in the Initial Setting Menu.
2. Switch the Warning Tone ON or OFF.

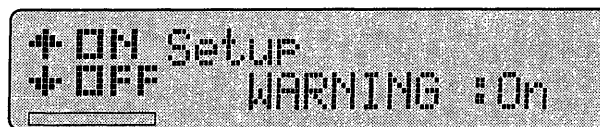
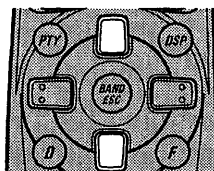
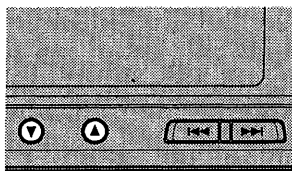

To cancel the Initial Setting Menu, press the BAND button.

Switching the AUX Mode

It is possible to use auxiliary (AUX) equipment with this product. Activate the AUX mode when using auxiliary equipment with this product.

1. Select the AUX Setting mode (AUX) in the Initial Setting Menu.
2. Switch the AUX mode ON or OFF.

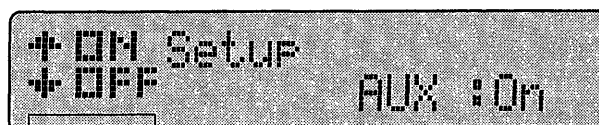
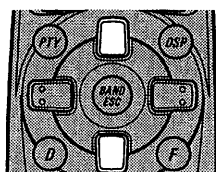
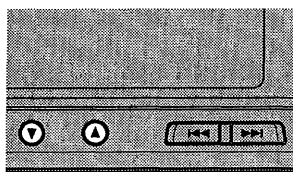

To cancel the Initial Setting Menu, press the BAND button.

Setting the Dimmer

To prevent this product's display from being too bright at night, when the vehicle's head lights are turned ON the display is dimmed. You can switch this function ON/OFF.

1. Select the Dimmer mode (Dimmer) in the Initial Setting Menu.
2. Switch the Dimmer ON or OFF.

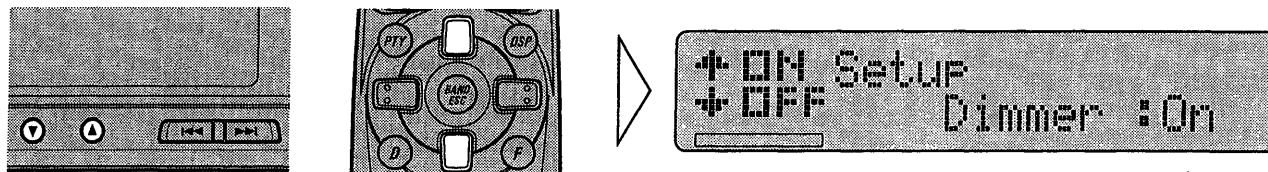

To cancel the Initial Setting Menu, press the BAND button.

Selecting the Illumination Color

This product is equipped with two illumination colors, green and red. You can select the desired illumination color.

1. Select the Illumination Color mode (ILM.Color) in the Initial Setting Menu.
2. Select the desired illumination color.

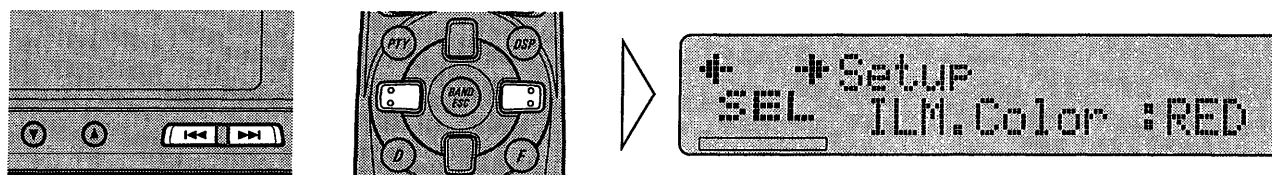

To cancel the Initial Setting Menu, press the BAND button.

Switching the DSP Output Level Setting

When sound appears distorted due to the equalizer curve or another reason, you can change this unit's DSP output level setting.

1. Select the DSP Output Level Setting mode (Sense) in the Initial Setting Menu.
2. Switch the DSP Output Level Hi or Low.

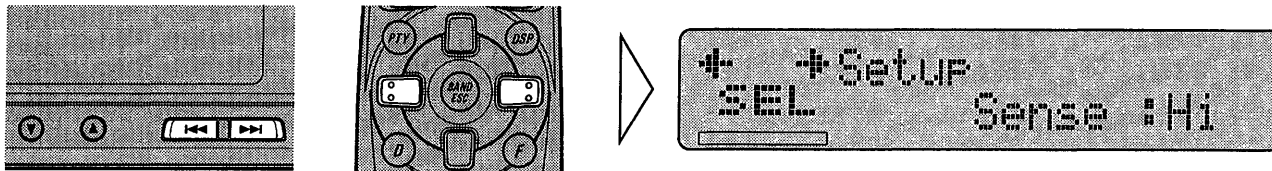

To cancel the Initial Setting Menu, press the BAND button.

Switching the Entertainment Display

When there's no Disc Title or other information, you can switch to the Entertainment Display.

1. Select the Entertainment Display mode (DISP Filler) in the Initial Setting Menu.
2. Switch the Entertainment Display ON or OFF.

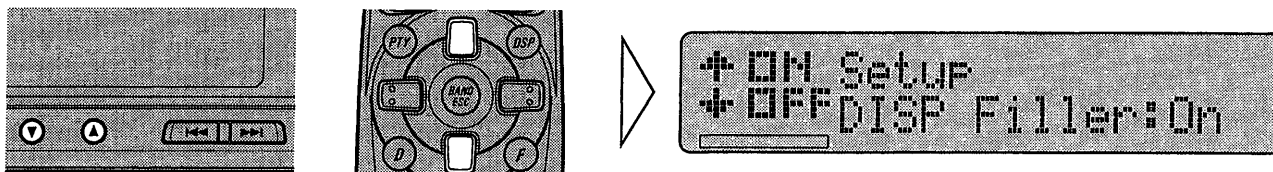

To cancel the Initial Setting Menu, press the BAND button.

RFP Alert Function

In addition to the Removable Front Panel of this product, Pioneer has incorporated a new feature “**Removable Front Panel Alert**”. This feature is designed to protect your new Pioneer car stereo as well as your vehicle contents.

Activating the RFP Alert Feature

Pioneer has developed a menu display that allows you to set-up your RFP Alert to meet your personal needs. By scrolling through this menu it is possible to select your own “Entry Delay Time”, “Speaker Output Volume”, “Selectable Output”, “Door System Type”, “Ignition Key Disarm” and “Remote Disarm”.

Initially from the factory the RFP Alert feature is not activated.

- 1. Select the RFP Alert Feature ON/OFF mode (Alarm) with the sources OFF.**

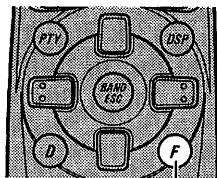

Hold for 2 seconds

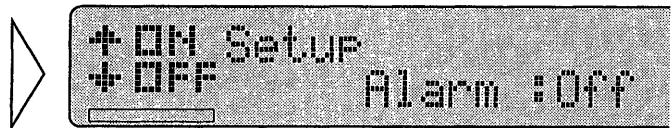

- 2. Activate the RFP Alert Feature.**

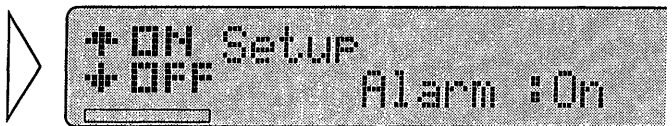
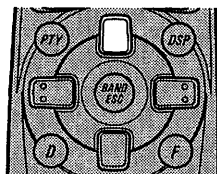
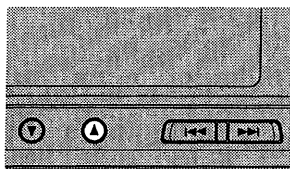

Press the ▼ button to deactivate the RFP Alert Feature.

- 3. Enter the RFP Alert Setting Menu.**

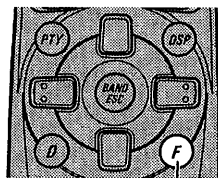

Hold for 2 seconds

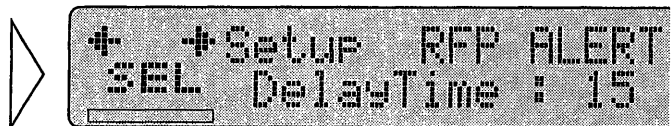

RFP Alert Function

Setting Entry Delay Time

Initially the “Entry Delay Time” is set to 15 seconds. The “Entry Delay Time” can be adjusted to be 0, 5, 15, 30, 45 or 60 seconds.

1. Decrease or increase the “Entry Delay Time”.

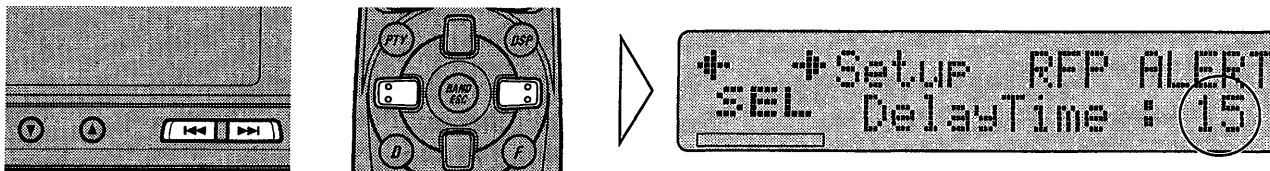

Display shows 0, 5, 15, 30, 45 or 60.

2. Advance to next selection.

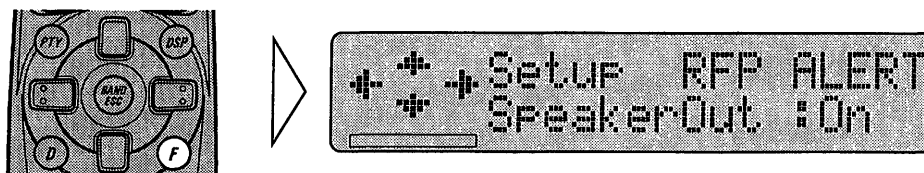

Switching Internal Speaker ON/OFF

This feature allows you to select whether or not there is speaker output when the “RFP Alert” is triggered. Initially from the factory the speaker output is activated. Toggling with the ▲, ▼ buttons allows you to deactivate or activate the “Internal Speaker”. If you switch the speaker output OFF, you can not change the “TEST MODE”.

Speaker Volume Output Adjustment

If the “Internal Speaker Output” has been selected then it is possible to adjust the volume of the speaker output for when the Alert is triggered. To adjust the volume you must engage the “TEST MODE”.

Note:

- If the “Internal Speaker Output” is turned OFF, then this menu will not appear.

1. Engage the "TEST MODE".

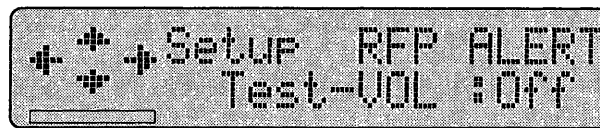
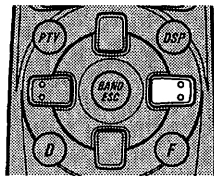
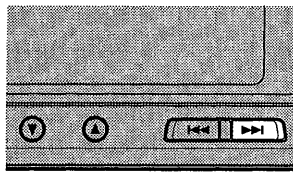

2. Activate the "TEST MODE".

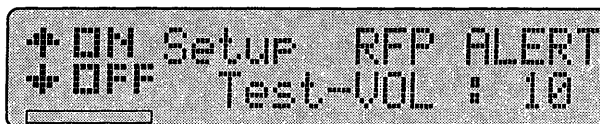
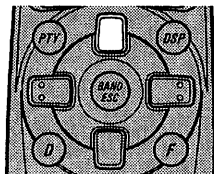
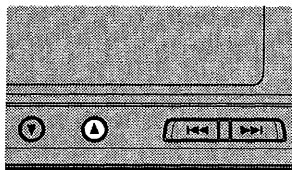

In this mode there is sound from the speaker.

3. Decrease or increase the volume.

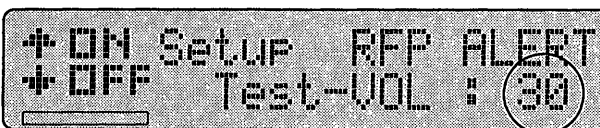
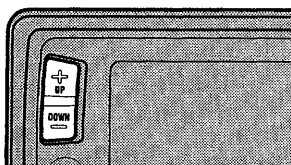

Display shows 10-40.

4. After selecting your preferred volume setting, deactivate the "TEST MODE".

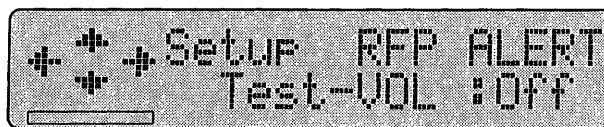
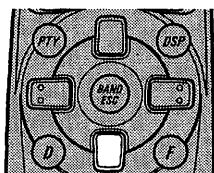
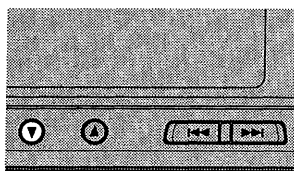

5. Cancel the "TEST MODE".

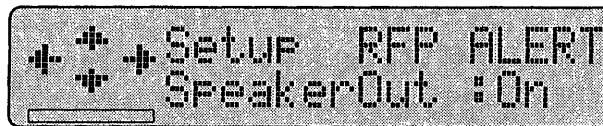
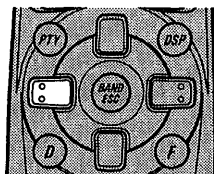
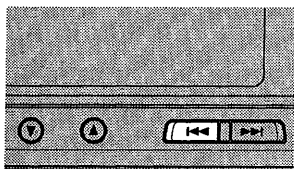

6. Advance to next selection.

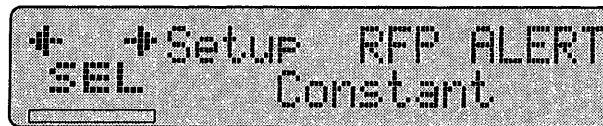
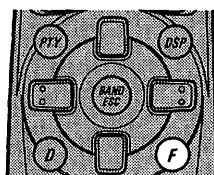

RFP Alert Function

Setting the Selectable Output (Pulse/Constant)

This mode enables you to select a “Constant” output or “Pulsed” output. When connecting a Siren the “Constant” output should be selected. When connecting the horn or lights the “Pulsed” output should be selected.

1. Select your desired output type.

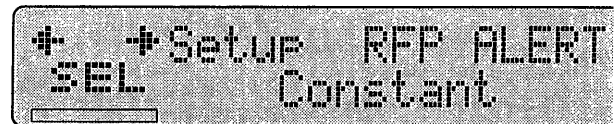
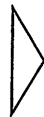
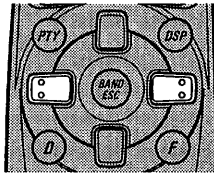
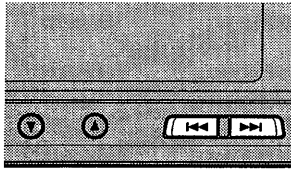

2. Advance to next selection.

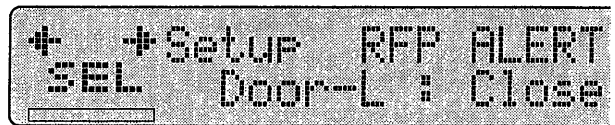
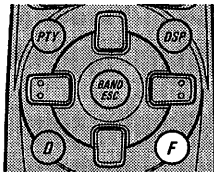

Selecting Door Switching Systems

It is necessary to select the correct “Door System Type” (Negative or Positive switching) for that of your vehicle. Initially, the system is set for vehicles with the grounding type (Negative switching).

Select the correct “Door system type” of your vehicle from below.

■ Vehicles to select “Door-L : Close”

EUROPEAN, JAPANESE, GM, CHRYSLER

■ Vehicles to select “Door-H : Close”

JAGUAR, MERCEDES*, FORD, etc

* Some Models Only.

- Select “Door-L : Close” or “Door-H : Close” for the correct door system type.

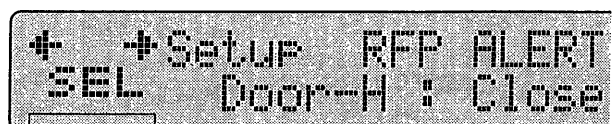
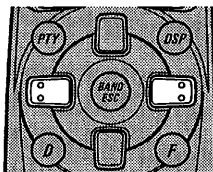
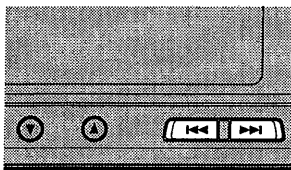

Door System Confirmation

The door system confirmation feature was incorporated to ensure that the correct door system type has been selected. (e.g. Set to "Door-H : Close" for JAGUAR vehicles.)

1. First, close all the doors. If the correct door system type has been selected then the Display will show "Door-H : Close".

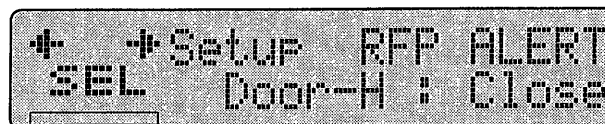
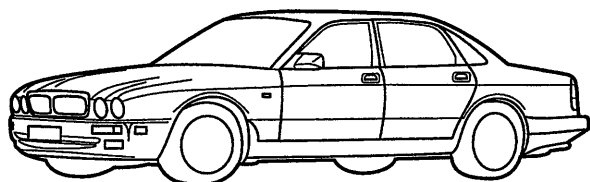

If not, select the alternative door system type by pressing the ◀ or ▶ button. Lastly, confirm each door triggers the Alert by opening and closing each door.

2. As the door is opened the display should change accordingly ("Door-H : Close" – "Door-H : Open").

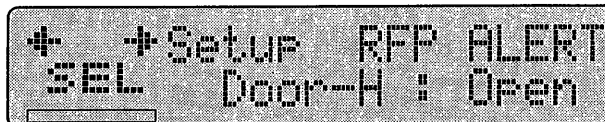
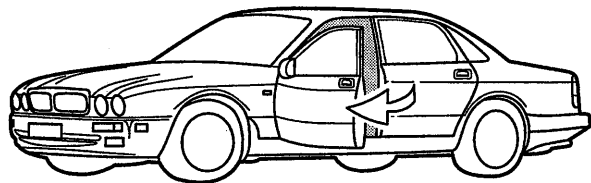

3. Advance to next selection.

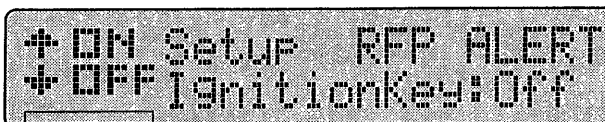
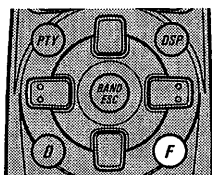

RFP Alert Function

Ignition Key Disarm

You can disarm "RFP Alert" with the ignition key if you have forgotten the Removable Front Panel.

The method for disarming "RFP Alert" with the ignition key differs depending on whether this function is switched ON or OFF.

■ If this function is "ON" or "OFF":

The "RFP Alert" can be disarmed if the Removable Front Panel is reattached within the "Entry Delay Time".

■ If this function is "ON":

The "RFP Alert" can be disarmed if the ignition key is inserted in the ignition within the "Entry Delay Time", then the key is turned from "OFF" to "ON" 5 times within 1 minute.

■ If this function is "OFF":

The "RFP Alert" can be disarmed if the ignition key is inserted in the ignition and turned from "OFF" position to the "ON" within the "Entry Delay Time".

1. Switch the Ignition Key Disarm ON or OFF.

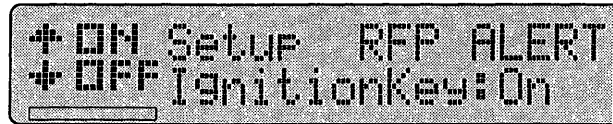
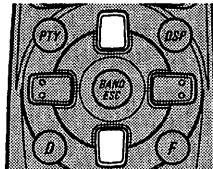
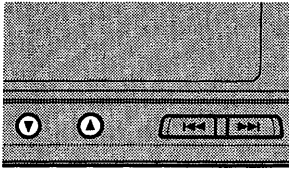

2. Advance to next selection.

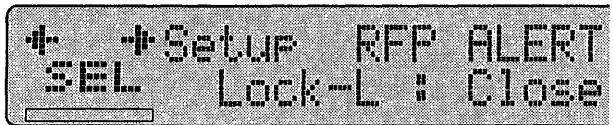
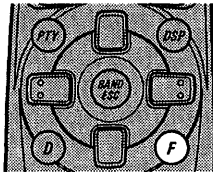

Central Door Lock Systems

The RFP Alert can be disarmed by unlocking the doors with a remote keyless entry system. If the unit's standby state is disarmed, the LED's blinking speed becomes faster. (The change in the LED's blinking speed lets you confirm that the "RFP Alert" has been disarmed.)

Note:

- If the "RFP Alert" is disarmed by the keyless entry system, it will remain disarmed. To reset, turn the ignition on, reattach the front panel then turn the ignition to the off position and remove the front panel.
- If your vehicle is equipped with a central door lock but the glass or shock sensor is not connected, if the window is broken and the central door lock is released, this unit's RFP Alert will not operate.
- Pioneer recommends that both a shock sensor and glass sensor be installed when you are using the "Remote Disarming" feature.

Selecting the Door Lock Type

- Select the "Lock-L : Close" or "Lock-H : Close" for the correct door lock type.

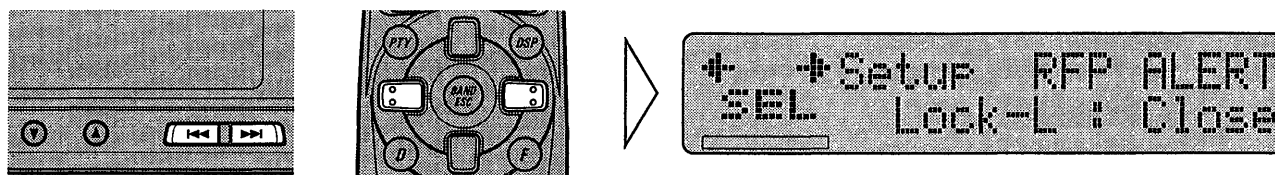

Door Lock Confirmation

The door lock confirmation feature was incorporated to ensure that the correct door lock type has been selected. (e.g. Set to "Lock-L : Close".)

1. As the doors are unlocked with central door lock system the display should flash "Lock-L : Open" accordingly.

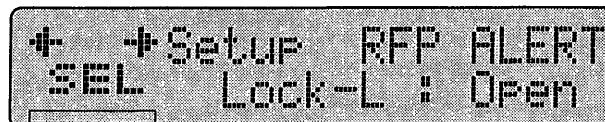

If not, select the alternative door lock type by pressing the ◀ or ▶ button.

RFP Alert Function

2. Cancel the RFP Alert Setting Menu.

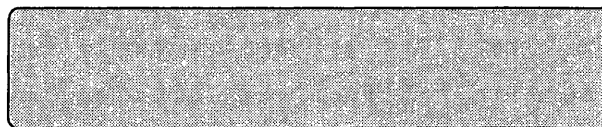
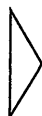
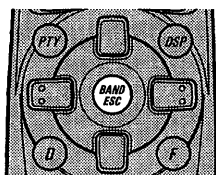

Setting of the "RFP Alert" is now complete.

Note:

- In the case that the battery is disconnected or the RESET button is pressed, it may be necessary to reprogram the RFP Alert Menu, otherwise this setting needs to be done only once.
- When the RFP Alert is armed, you cannot disarm it by pressing the RESET button.

Operation of "RFP Alert"

Providing the installation and setting of the "RFP Alert Setting Menu" has been performed correctly, operation of the "RFP Alert" is very simple.

Arming Alert

To arm your Alert simply turn off the ignition and detach the front panel, as described on page 10. After detaching the front panel the "RFP Alert" will automatically arm itself after 30 seconds, providing all of the doors are closed. If after 30 seconds, a door still remains open the RFP Alert will not arm until the last door has been closed. After closing all of the doors, ensure that they are securely locked. The LED indicator on the head unit will flash as a visual deterrent. Your vehicle is now protected by your "RFP Alert".

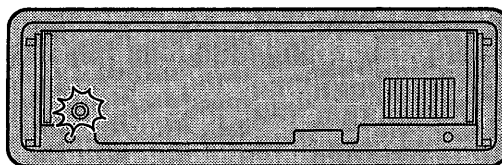
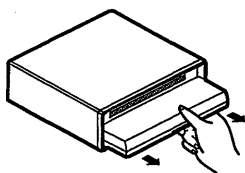

Disarming Alert

Upon entering your vehicle, and within the “Entry Delay Time” set within the “RFP Alert Menu”, attach your Pioneer Removable Front Panel as described on page 10.

If you have forgotten the Removable Front Panel

If the “Ignition Key Disarm” is “ON”, insert the ignition key in the ignition within the “Entry Delay Time”, then turn the key from “OFF” to “ON” 5 times within 1 minute.

If the “Ignition Key Disarm” is “OFF”, insert the ignition key in the ignition and turn the key from “OFF” to “ON” within the “Entry Delay Time”.

Entry Detection

If the “RFP Alert” was not disarmed in accordance with “Disarming Alert”, the “RFP Alert” will be triggered! The “RFP Alert” will sound for 60 seconds and will repeat 5 times if any door is left open or reopened. After the fifth time the “RFP Alert” will reset to prevent continuous sounding and prevent your battery from discharging.

Precaution:

- Upon returning to your vehicle and before opening any doors, check to see if the LED indicator is still flashing. If the LED is no longer flashing, it indicates that the Alert has sounded. Disarming, as described above, is still necessary.

Other Functions

Using the PGM Button

The PGM button can memorize one of the functions in the Function Menu. It is possible to memorize a different function for each source.

Setting the PGM Button

1. Select the PGM button setting mode.

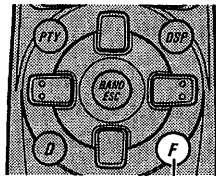

Hold for 2 seconds

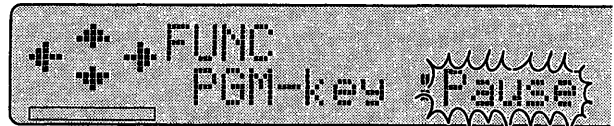

2. Select the function you want to memorize in the PGM button.

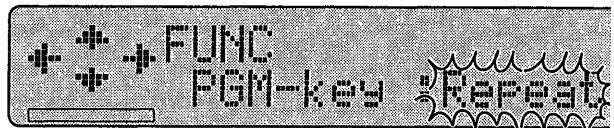
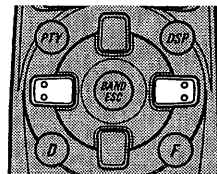
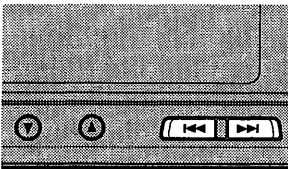

3. Memorize the function in the PGM button.

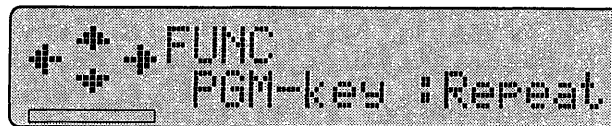
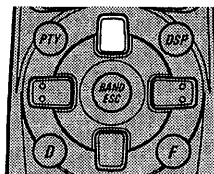
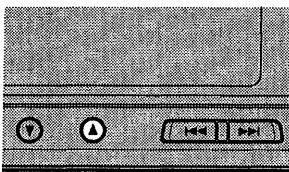

To cancel the PGM button setting mode, press the BAND button.

Using the PGM Button

The PGM button operates in a different way depending on the function programmed (memorized).

- Use the PGM button.

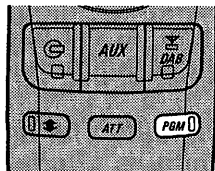

Tuner

Function	Press	Hold for 2 seconds
BSM	OFF	ON
REG	ON/OFF	—
Local	ON/OFF	Entering the Local Seek sensitivity (only when Local is ON)

Built-in CD Player

Function	Press	Hold for 2 seconds
Pause	ON/OFF	—
Repeat	ON/OFF	—
Random	ON/OFF	—

Multi-CD Player

Function	Press	Hold for 2 seconds
Pause	ON/OFF	—
Repeat	Selecting the mode	—
Random	ON/OFF	—
List	Enter the List mode	—
ITS	ITS Programming	ON/OFF

Multi-MD Player

Function	Press	Hold for 2 seconds
Repeat	Selecting the mode	—
Random	Selecting the mode	—
List	Enter the List mode	—

Other Functions

Adjusting the Angle and Contrast

1. Enter the Angle and Contrast mode.

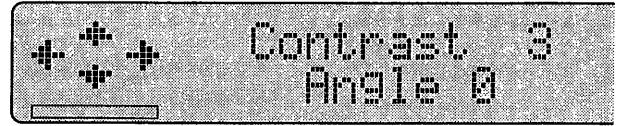
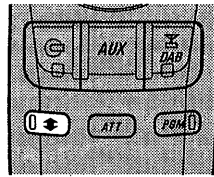
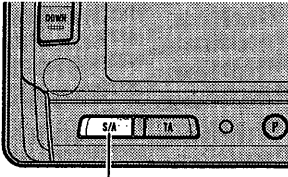

Hold for 2 seconds

2. Adjust the angle.

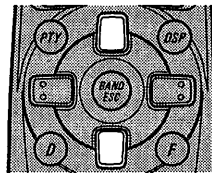
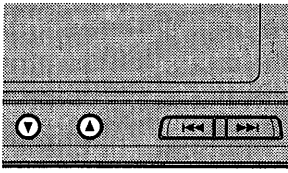

The display shows “Angle 0” – “Angle 4”

Note:

- If you press the ▲ button during angle adjustment, the setting returns to “Angle 0”.

3. Adjust the contrast:

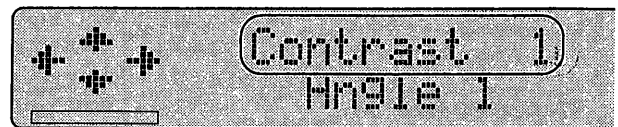
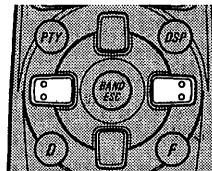
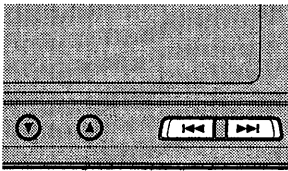

The display shows “Contrast -7” – “Contrast 7”

To cancel this mode, press the BAND button.

Note:

- Depending on where you install the remote controller, if you perform front panel angle adjustment, operation with the remote controller may not be possible. If this happens, operate the remote controller near this unit.

Precaution:

- A few seconds after turning the ignition switch to ON/OFF, the front panel automatically moves. When this happens, your fingers may become jammed in the panel, so keep your hands away from it.

Selecting the Status Display

This unit's Status Display lets you switch between source, Spectrum Analyzer, and other indications.

Note:

- The Spectrum Analyzer Display pattern changes depending on the style of music playing.
- Select the desired display.**

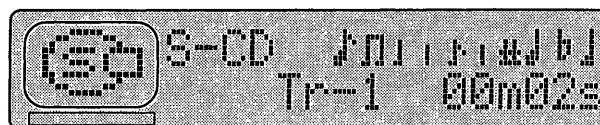
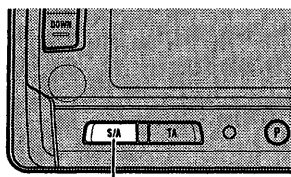

Each press
changes the Display ...

Each press of the S/A button changes the display in the following order:

Source Display → SF/AS* → AF/TA → Pattern 1 → Pattern 2
→ Pattern 3 → Pattern 4

- * "SF/AS" is a function of the "GEX-P900DAB" Hide-away DAB tuner. You cannot switch to this function if a Hide-away DAB tuner is not connected.

Note:

- "SF/AS" and "AF/TA" are confirmation displays for different function settings. When they are switched ON, the display becomes negative.

Volume Attenuator

The attenuator reduces the volume instantly.

- Cut the volume by about 90%.**

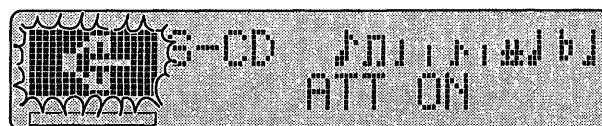
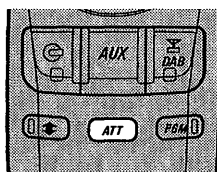

Repeat the preceding operation to return to previous volume.

If the (+) or (-) button is used to cancel the Attenuator mode, the sound will resume at a lower volume than before.

Other Functions

Using the AUX Mode

It is possible to use auxiliary (AUX) equipment with this product.

Activate the AUX mode when using auxiliary equipment with this product.

Selecting the AUX mode

- **Select AUX.**

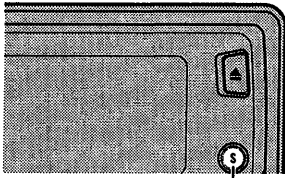

Each press
changes the Source ...

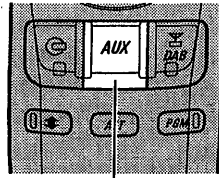

Each press
changes the Source ...

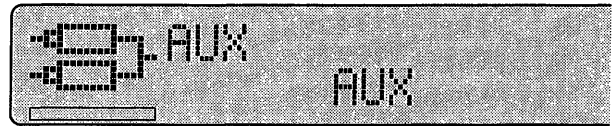

AUX Title Input

The display title for AUX mode can be changed.

1. **Select the Aux Title Input mode in the Detailed Setting Menu.**

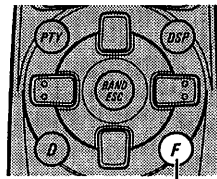

Hold for 2 seconds

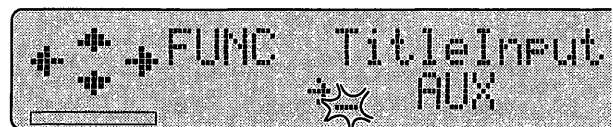

2. **Input the Aux Title.**

Refer to "Disc Title Input" on page 45, and perform procedures 3 to 6 in the same way.

Cellular Telephone Muting

Sound from this system is muted automatically when a call is made or received using a cellular telephone connected to this product.

- The sound is turned off, "MUTE" is displayed and no audio adjustment except volume control is possible. Operation returns to normal when the phone connection is ended.

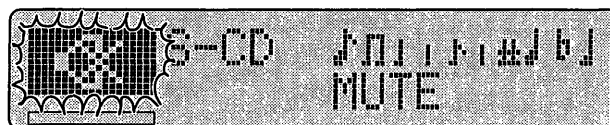

Basic Operation of Multi-MD Players

1. Select the multi-MD player source.

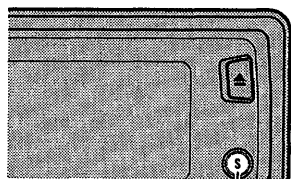

Each press changes the Source ...

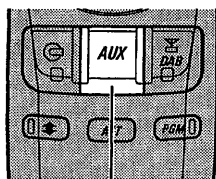

Each press changes the Source ...

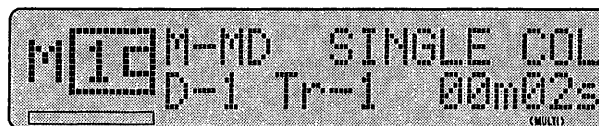

Note:

- If there are no discs in the multi-MD player, "NO DISC" is displayed.

2. Select the desired disc.

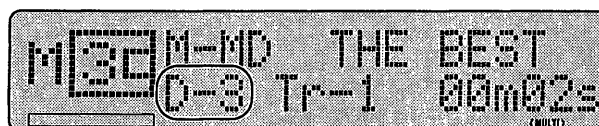
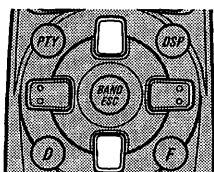
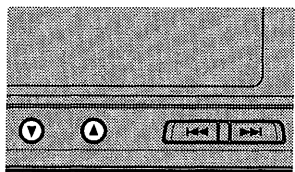

3. Select the desired track (or fast-forward/reverse, per the chart below).

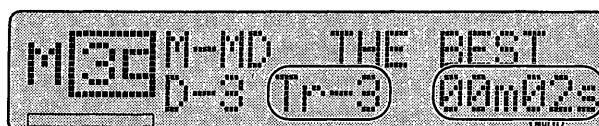
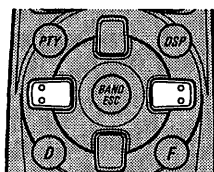
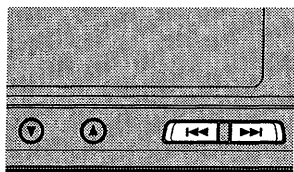

This product lets you select the track search function or fast-forward/reverse function by changing the length of the time you press the button.

Track search	0.5 seconds or less
Fast-forward/Reverse	Continue pressing

Using Multi-MD Players

4. Raise or lower the volume.

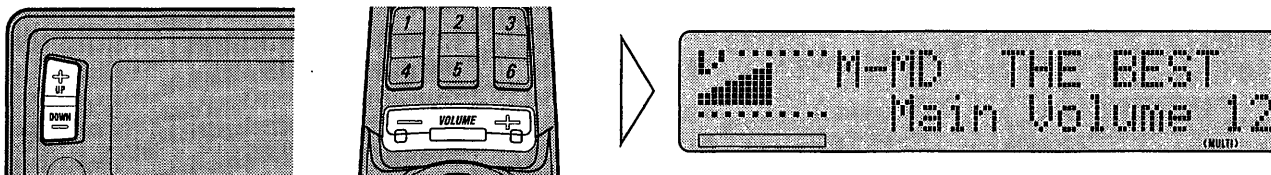

5. Turn the source OFF.

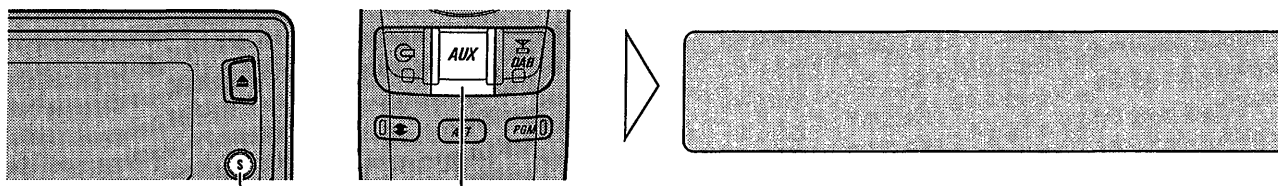

Hold for 1 second

Each press
changes the Source ...

Note:

- If you press the STOP button of a multi-MD player when it is playing, "STOP" is displayed and the multi-MD player stops playing. If you perform Disc Search at this time, the multi-MD player starts playing once more. (refer to previous page.)
- The multi-MD player reads and memorizes music data recorded on an MD before reproducing it. Because of this, you can enjoy the following features.
 - * When the last track on an MD has finished, the player automatically changes to the next MD. Because this change occurs while music data is being played from memory, the interval between the end of the last track on one MD and the start of the first track on the next is shorter.
 - * During the time taken to switch between MDs using Disc Search, memorized music data of the previous track is played at reduced volume level.

Disc Number Search

You can select discs directly with the 1-6 buttons. Just press the number corresponding to the disc you want to listen to.

- **Select the desired disc. (e.g. Press button 3.)**

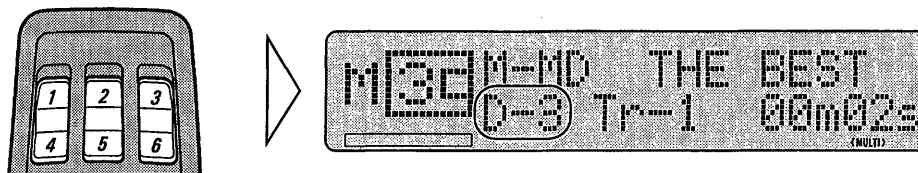

Title Display Function

Switching the Title Display

You can display disc title or track title when the multi-MD player is playing.

- **Select the desired title display.**

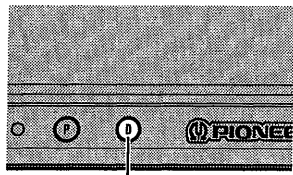

Each press
changes the Display ...

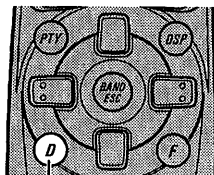

Each press
changes the Display ...

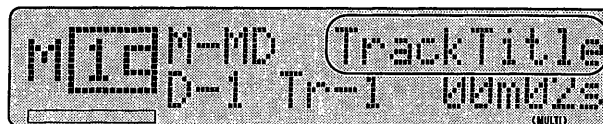

Each press of the DISPLAY button selects the display in the following order:

Disc Title (Disc Title) → Track Title (TrackTitle)

Note:

- During Repeat Play, Random Play and Scan Play, Elapsed Play Time indications change to ON/OFF indications for each of the above play modes. (Refer to page 106.)
- If you do not input a disc's name, "No D-Data" is indicated in the Disc Name display. If you do not input a track's name, "No Tr-Data" is indicated in the Track Name display.

Scrolling the Title Display

Displayed disc and track names are only up to 10 letters long, but indications can be scrolled.

- **Scroll the title display.**

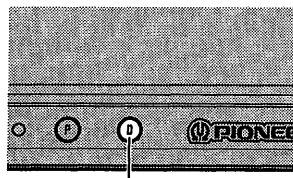

Hold for 2 seconds

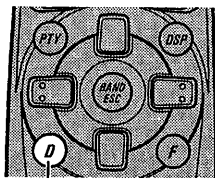

Hold for 2 seconds

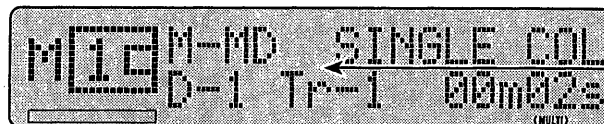

Note:

- By scrolling, you can display disc and track names up to 200 letters long.

Using Multi-MD Players

Entering the Function Menu

In this menu you can select multi-MD player functions.

- **Select the desired mode in the Function Menu.**

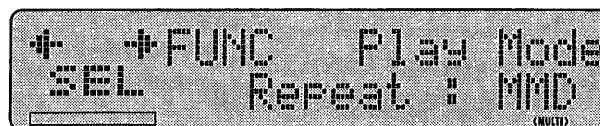
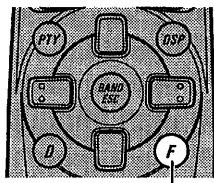

Each press
changes the Mode ...

Each press of the FUNCTION button selects the mode in the following order:

Repeat → ListSearch → Random → Scan

To cancel the Function Menu, press the BAND button.

Note:

- After entering the Function Menu, if you do not perform an operation within about 30 seconds, the Function Menu is automatically canceled.

Repeat Play

There are two Repeat Play modes: One-track Repeat and Disc Repeat.

Mode	Operation
One-track Repeat	The track currently playing is repeated.
Disc Repeat	The MD currently playing is repeated.

1. **Select the Repeat mode (Play Mode) in the Function Menu.**
2. **Select the desired repeat play mode in the following order:**

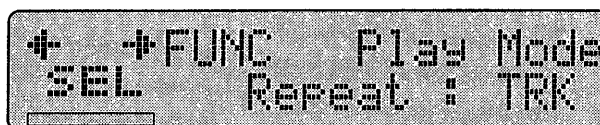
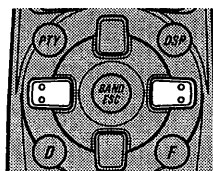
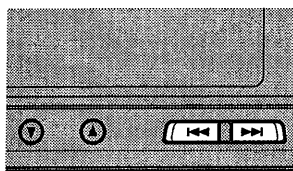

One-track Repeat ("TRK" is displayed.) → Disc Repeat ("DSC" is displayed and "DISC" indicator lights.) → OFF ("MMD" is displayed and "MULTI" indicator lights.)

To cancel the Function Menu, press the BAND button.

Selecting Discs by Disc Title

You can select the desired disc with its title.

1. Select the Disc Title List mode (ListSearch) in the Function Menu.
2. Select the disc title of desired disc.

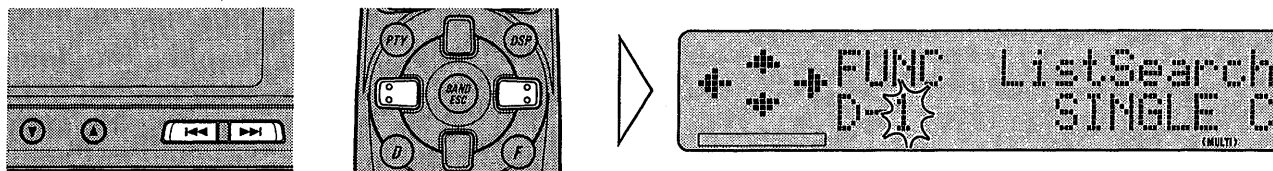

Nothing is displayed for disc whose titles have not been input.

3. Switch to the disc of selected disc title.

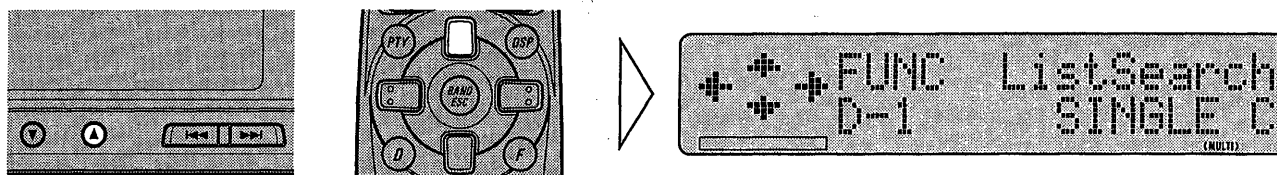

To cancel the Function Menu, press the BAND button.

Note:

- When "NOT RDY" is displayed, disc titles can be read by performing step 3.

Random Play

There are two Random Play modes: Random 1 and Random 2.

Mode	Operation
Random 1	Tracks on the MD that's playing are played in random order. When all the tracks on the MD that's playing have been played, Random Play begins on the next MD.
Random 2	All tracks on all the MDs are played in random order.

1. Select the Random mode (Random) in the Function Menu.

Using Multi-MD Players

2. Select the desired random play mode in the following order:

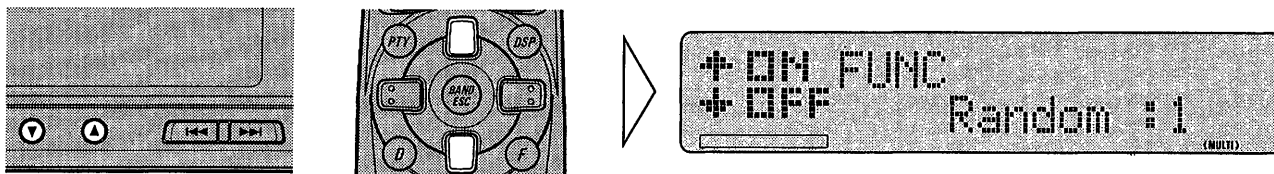

Random 1 ("Random :1" is displayed.) → Random 2 ("Random :2" is displayed.) → OFF ("Random :Off" is displayed.)

To cancel the Function Menu, press the BAND button.

Scan Play

There are two Scan Play modes: Track Scan and Disc Scan.

Mode	Operation
Scan 1	Use this to find a desired track. All tracks on all the MDs are played for about 10 seconds each.
Scan 2	Use this to find a desired MD. About 10 seconds of the first track on each disc is played.

1. Select the Scan mode (Scan) in the Function Menu.

2. Select the desired scan play in the following order:

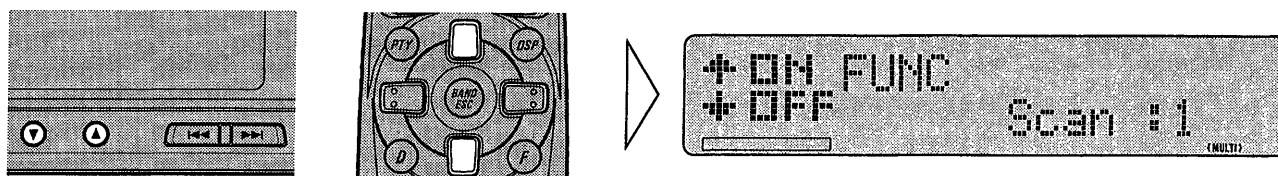

Scan 1 ("Scan :1" is displayed.) → Scan 2 ("Scan :2" is displayed.) → OFF ("Scan :Off" is displayed.)

3. When you hear the track you are looking for, cancel Scan Play.

If the Function Menu has been canceled automatically, select the Scan mode in the Function Menu again.

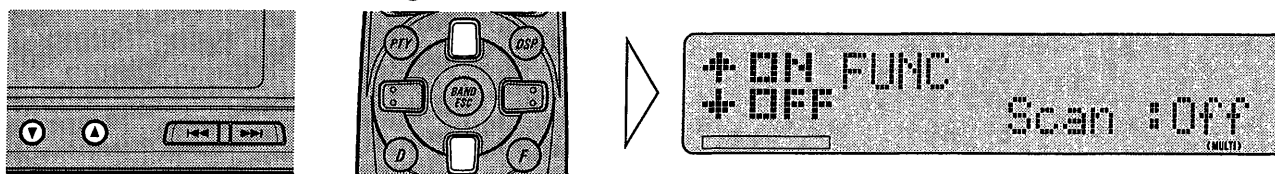

To cancel the Function Menu, press the BAND button.

Combining Random Play, Scan Play and Repeat Play

You can combine Random mode, Scan mode and Repeat mode play as follows.

Display	Indicator	Play Type
RDM 1	MULTI	Random 1
S.RDM1	MULTI	Random 1 and Track Scan
RDM 1	DISC	Random 1 and Disc Repeat
S.RDM1	DISC	Random 1, Track Scan and Disc Repeat
RDM 2	MULTI	Random 2
S.RDM2	MULTI	Random 2 and Track Scan
T Scan	MULTI	Track Scan
T Scan	DISC	Track Scan and Disc Repeat
D Scan	MULTI	Disc Scan
Repeat	———	One Track Repeat
Repeat	DISC	Disc Repeat

Multi-MD Player's Error Message

When problems occur with MD playback, an error message appears on the display. Refer to the table below to identify the problem, then take the suggested corrective action. If the error persists, contact your dealer or your nearest PIONEER Service Center.

Message	Possible cause	Recommended action
No D-Data	Disc name has not been input.	Switch to a display other than Disc Name indications.
No Tr-Data	Track name has not been input.	Switch to a display other than Track Name indications.
BLANK DISC	Nothing is recorded on the MD.	Exchange the MD for one that has music recorded on it.
HEAT	Player overheating.	Wait until the temperature inside the player drops.
STOP	STOP button has been pressed on the player.	Select the disc number of a loaded MD using Disc Search or Disc Number Search.
NO DISC	No MD loaded in the player.	Load an MD.
ERROR-	MD play not possible.	Replace the MD with another disc, or press the Reset button.

Specifications

General

Power source 14.4 V DC (10.8 – 15.1 V allowable)
Grounding system Negative type
Max. current consumption 4 A
Dimensions
(mounting size) 178 (W) × 50 (H) × 155 (D) mm
(front face) 188 (W) × 58 (H) × 20 (D) mm
Weight 1.8 kg

Preout

Maximum preout output level 4 V
Preout impedance less than 100 Ω

CD player

System Compact disc audio system
Usable discs Compact disc
Signal format Sampling frequency: 44.1 kHz
Number of quantization bits: 16; linear
Frequency characteristics 5 – 20,000 Hz (±1 dB)
Signal-to-noise ratio 120 dB (1 kHz) (IEC-A network)
Dynamic range 98 dB (1 kHz)
Number of channel 2 (stereo)

FM tuner

Frequency range 87.5 – 108 MHz
Usable sensitivity
..... 11 dBf (1.0 μV/75 Ω, mono, S/N: 30 dB)
50 dB quieting sensitivity 16 dBf (1.7 μV/75 Ω, mono)
Signal-to-noise ratio 70 dB (IEC-A network)
Distortion 0.3% (at 65 dBf, 1 kHz, stereo)
Frequency response 30 – 15,000 Hz (±3 dB)
Stereo separation 40 dB (at 65 dBf, 1 kHz)

MW tuner

Frequency range 531 – 1,602 kHz
Usable sensitivity 18 μV (S/N: 20 dB)
Selectivity 50 dB (±9 kHz)

LW tuner

Frequency range 153 – 281 kHz
Usable sensitivity 30 μV (S/N: 20 dB)
Selectivity 50 dB (±9 kHz)

DSP**Equalizer (13 Band Graphic Equalizer)**

Frequency 50, 80, 125, 200, 315, 500, 800,
1.25 k, 2 k, 3.15 k, 5 k, 8 k, 12.5 k (Hz)
Level ± 12 dB (2 dB)

Auto Equalizer (STD Mode)

(Front & Rear & Subwoofer 13 band graphic + Rear 2
band parametric)

Frequency (Front & Rear & Subwoofer)
..... 50, 80, 125, 200, 315, 500, 800,
1.25 k, 2 k, 3.15 k, 5 k, 8 k, 12.5 k (Hz)

Frequency (Rear) 100 Hz – 8 kHz (1/3 oct)

Level +6 — -12 dB (2 dB)

Q Factor (Rear) 1.2, 3.6

Auto Equalizer (PRO Mode)

(13 band graphic)

Frequency 50, 80, 125, 200, 315, 500, 800,
1.25 k, 2 k, 3.15 k, 5 k, 8 k, 12.5 k (Hz)

Level +6 — -12 dB (2 dB)

Network (STD Mode)

Front/Rear HPF frequency: 50, 80, 125, 200 (Hz)

Slope: 0, -6, -12 dB/oct

Level: 0 — -24 dB (1 dB)

Subwoofer (Mono)

..... LPF frequency: 50, 63, 80, 100,
125, 160, 200 (Hz)

Slope: -6, -12, -18 dB/oct

Level: +6 — -24 dB (1 dB)

Phase: Normal/Reverse

Network (PRO Mode)

High HPF frequency: 2 k, 2.5 k, 3.15 k, 4 k, 5 k,
6.3 k, 8 k, 10 k, 12.5 k (Hz)

Slope: -6, -12, -18, -24 dB/oct

Level: +6 — -24 dB (1 dB)

Phase: Normal/Reverse

Mid LPF frequency: 2 k, 2.5 k, 3.15 k, 4 k, 5 k,
6.3 k, 8 k, 10 k, 12.5 k (Hz)

HPF frequency: 40, 50, 63, 80, 100, 125,
160, 200, 250 (Hz)

Slope: 0, -6, -12, -18, -24 dB/oct

Level: 0 — -24 dB (1 dB)

Phase: Normal/Reverse

Low (Stereo/Mono)

..... LPF frequency: 40, 50, 63, 80, 100,
125, 160, 200, 250 (Hz)

Slope: -12, -18, -24, -30, -36 dB/oct

Level: +6 — -24 dB (1 dB)

Phase: Normal/Reverse

Time Alignment 0 — 400 cm (2 cm)

0 — 160 inch (0.5 inch)

Note:

- Specifications and the design are subject to possible modification without notice due to improvements.